

Aficio™ AP410N/AP410

Setup Guide

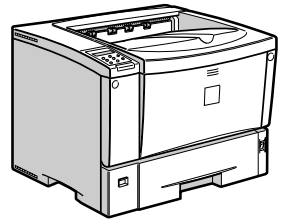

-
- 1** Guide to the Printer
 - 2** Setting Up
 - 3** Installing Options
 - 4** Connecting the Printer
 - 5** Configuration
 - 6** Installing the Printer Driver

Introduction

This manual contains detailed instructions and notes on the operation and use of this machine. For your safety and benefit, read this manual carefully before using the machine. Keep this manual in a handy place for quick reference.

Power Source

220 - 240 V, 50/60 Hz, 4.1 A or more

Please be sure to connect the power cable to a power source as above.

Laser Safety:

This machine is considered a class I laser device, safe for office/ EDP use. The machine contains 7 milliwatt, 645 - 660 nanometer wavelength, A1GaInP Laser Diode. Safety precautions and interlock mechanisms have been designed to prevent any possible laser beam exposure to the operator.

The following label is attached behind the front cover, left side, front facing.



Important

Contents of this manual are subject to change without prior notice. In no event will the company be liable for direct, indirect, special, incidental, or consequential damages as a result of handling or operating the machine.

Caution:

Use of controls or adjustments or performance of procedures other than those specified in this manual might result in hazardous radiation exposure.

Do not copy or print any item for which reproduction is prohibited by law.

Copying or printing the following items is generally prohibited by local law:

bank notes, revenue stamps, bonds, stock certificates, bank drafts, checks, passports, driver's licenses.

The preceding list is meant as a guide only and is not inclusive. We assume no responsibility for its completeness or accuracy. If you have any questions concerning the legality of copying or printing certain items, consult with your legal advisor.

Two kinds of size notation are employed in this manual. With this machine refer to the metric version.

For good print quality, the supplier recommends that you use genuine toner, maintenance kits and parts from the supplier.

The supplier shall not be responsible for any damage or expense that might result from the use of consumables (toner, maintenance kits and parts) other than genuine consumables from the supplier with your office products.

Some illustrations in this manual might be slightly different from the machine.

Certain options might not be available in some countries. For details, please contact your local dealer.

TABLE OF CONTENTS

Trademarks.....	1
Safety Information	2
Positions of ⚠WARNING and ⚠CAUTION labels	5
ENERGY STAR Program	6
Manuals for This Printer.....	7
How to Read This Manual	8

1. Guide to the Printer

Exterior	9
Inside.....	11
Control Panel.....	12

2. Setting Up

Where to Put the Printer.....	13
Unpacking the Printer and Checking the Contents of the Box	16
Installing the Toner Cartridge.....	17
Loading Paper	20
Turning the Power On	22
Selecting the Display Language.....	23
Test Printing	24

3. Installing Options

Available Options.....	25
Option List	25
Option Installation Flow Chart.....	26
Installing Options.....	27
Attaching Paper Feed Unit Type 400.....	30
Attaching Envelope Feeder Type 400	32
Attaching Memory Unit Type C (SDRAM Module)	33
Attaching Network Interface Board Type 2610	36
Attaching 1394 Interface Unit Type 4510	39
Attaching 802.11b Interface Unit Type F.....	42
Attaching Bluetooth Interface Unit Type C.....	46
Attaching Hard Disk Drive Type 2600	50
Attaching Network Data Protection Unit Type B.....	51
Attaching AD450 (Duplex Unit).....	52

4. Connecting the Printer

Network Connection	55
USB Connection.....	57
Parallel Connection	58
IEEE 1394 Connection	59

5. Configuration

Ethernet Configuration.....	61
IEEE 802.11b (Wireless LAN) Configuration	64
IEEE 1394 Configuration	68
IP over 1394	68
SCSI print.....	69

6. Installing the Printer Driver

Quick Install.....	71
Install the Operating Instructions.....	73
INDEX.....	74

Trademarks

Microsoft, Windows and Windows NT are registered trademarks of Microsoft Corporation in the United States and/or other countries.

IPS-PRINT Printer Language Emulation Copyright© 1999-2000 Oak Technology, Inc., All rights reserved.

Bluetooth® is a registered trademark of the Bluetooth SIG, Inc. worldwide.

Other product names used herein are for identification purposes only and might be trademarks of their respective companies. We disclaim any and all rights to those marks.

The proper names of the Windows operating systems are as follows:

- Microsoft® Windows® 95 operating system
- Microsoft® Windows® 98 operating system
- Microsoft® Windows® Millennium Edition (Windows Me)
- The product names of Windows® 2000 are as follows:
 - Microsoft® Windows® 2000 Advanced Server
 - Microsoft® Windows® 2000 Server
 - Microsoft® Windows® 2000 Professional
- The product names of Windows® XP are as follows:
 - Microsoft® Windows® XP Professional
 - Microsoft® Windows® XP Home Edition
- The product names of Windows Server™ 2003 are as follows:
 - Microsoft® Windows Server™ 2003 Standard Edition
 - Microsoft® Windows Server™ 2003 Enterprise Edition
 - Microsoft® Windows Server™ 2003 Web Edition
- The product names of Windows NT® 4.0 are as follows:
 - Microsoft® Windows NT® Server 4.0
 - Microsoft® Windows NT® Workstation 4.0

Safety Information

When using your printer, the following safety precautions should always be followed.

In this manual, the following important symbols are used:

 **WARNING:**

Indicates a potentially hazardous situation which, if instructions are not followed, could result in death or serious injury.

 **CAUTION:**

Indicates a potentially hazardous situation which, if instructions are not followed, may result in minor or moderate injury or damage to property.

 **WARNING:**

- ***Confirm the wall outlet is near the machine and freely accessible, so that in the event of emergency, it can be unplugged easily.***
- ***Only connect the machine to the power source described in the manual.***
- ***Avoid multi-wiring.***
- ***Do not damage, break or make any modifications to the power cord. Do not place heavy objects on it, pull it hard or bend it more than necessary. These actions could cause an electric shock or fire.***
- ***Do not incinerate spilled toner or used toner. Toner dust is flammable and might ignite when exposed to an open flame.***
- ***Disposal should take place at an authorized dealer or an appropriate collection site.***
- ***If you dispose of the used toner cartridges yourself, dispose of them according to local regulations.***
- ***Do not store toner, used toner, or toner containers in a place with an open flame. The toner might ignite and cause burns or a fire.***
- ***Plug and unplug the power cable with dry hands, or an electric shock could occur.***
- ***Do not risk electric shock by handling the power cord or plug with wet hands.***
- ***Do not remove any covers or screws other than those specified in this manual. Some parts of the machine are at a high voltage and could give you an electric shock. Also, if the machine has laser systems, direct (or indirect) reflected eye contact with the laser beam may cause serious eye damage. When the machine needs to be checked, adjusted, or repaired, contact your service representative.***
- ***Do not take apart or attempt any modifications to this machine. There is a risk of fire, electric shock, explosion or loss of sight. If the machine has laser systems, there is a risk of serious eye damage.***

⚠ WARNING:

- ***Be sure to turn off the power switch and wait for about 15 minutes before cleaning the Registration roller. Not waiting for the printer to cool down can result in a burn.***
- ***The supplied power cord is for use with this equipment only. Do not use with other appliances. Doing so may result in fire, electric shock, or injury.***
- ***Keep the machine away from flammable liquids, gases, and aerosols. A fire or an electric shock might occur.***

⚠ CAUTION:

- *Do not handle the plug with wet hands. Doing so might cause an electrical shock.*
- *Keep the machine in an area that is within optimum environmental conditions. Operating the machine in an environment that is outside the recommended ranges of humidity and temperature can cause an electrical fire hazard. Keep the area around the socket free of dust. Accumulated dust can become an electrical fire hazard.*
- *Place the machine on a strong and level surface. Otherwise, it might fall and injure someone.*
- *If you use the machine in a confined space, ensure there is continuous air circulation.*
- *Keep toner (used or unused) and the toner containers out of reach of children.*
- *If toner or used toner is inhaled, gargle with plenty of water and move into a fresh air environment. Consult a doctor if necessary.*
- *If your skin comes into contact with toner or used toner, wash the affected area thoroughly with soap and water.*
- *If toner or used toner gets into your eyes, flush immediately with large amounts of water. Consult a doctor if necessary.*
- *If toner or used toner is swallowed, dilute by drinking a large amount of water. Consult a doctor if necessary.*
- *Avoid getting toner on your clothes or skin when removing a paper jam or replacing toner. If your skin comes into contact with toner, wash the affected area thoroughly with soap and water.*
- *If toner gets on your clothing, wash with cold water. Hot water will set the toner into the fabric and may make removing the stain impossible.*
- *Our products are engineered to meet the highest standards of quality and functionality. When purchasing expendable supplies, we recommend using only those provided by an authorized dealer.*

⚠ CAUTION:

- *Do not pull out the paper tray forcefully. If you do, the tray might fall and cause an injury.*
- *Before installing options, the machine should be turned off and unplugged for at least an hour. Components inside the machine become very hot, and can cause a burn if touched.*
- *Before moving the machine, unplug the power cable from the outlet. If the cable is unplugged abruptly, it could become damaged. Damaged plugs or cables can cause an electrical or fire hazard.*
- *When lifting the machine, use the grips on both sides. The machine could break or cause an injury if dropped.*
- *The printer weighs about 17 kg (37.5 lb.). When lifting the machine, use the inset grips on both sides. Otherwise the printer could break or cause injury if dropped.*
- *Do not touch the inside of the controller board compartment. Doing so may cause a malfunction or a burn.*
- *The inside of this printer becomes very hot. Do not touch parts labelled “⚠” (indicating a hot surface). Touching these parts will result in burns.*
- *Grip the plug, not the cord, when pulling the plug from the socket. Pulling the cord causes wear and tear that can result in fire or electric shock.*
- *Lifting the paper feed unit carelessly or dropping it may cause injury.*
- *When removing misfed paper, do not touch the fusing section because it becomes very hot.*
- *When you move the printer, remember to unplug the power cord from the wall outlet to avoid a fire or an electric shock.*
- *When you pull out the plug from the socket, grip the plug, not the cord, to avoid damaging the cord and causing a fire or an electric shock.*
- *When moving the printer after use, do not take out any of the Toners, Photo Conductor Units, nor the Waste Toner Bottle to prevent toner spill inside the machine.*

Positions of ⚠️ WARNING and ⚠️ CAUTION labels

This machine has labels for ⚠️ WARNING and ⚠️ CAUTION at the positions shown below. For safety, please follow the instructions and handle the machine as indicated.

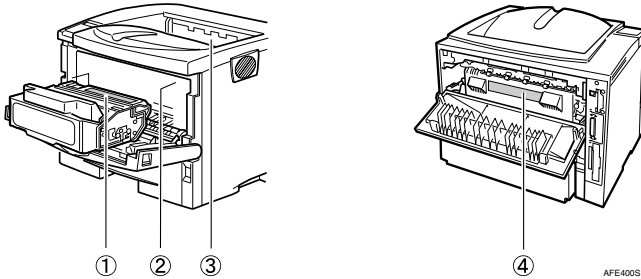

①

WARNING ATTENTION WARNING AVVISO AVISO ADVERTENCIA 警告		● Do not incinerate toner or toner containers.
		● Toner dust may cause flashback when exposed to an open flame.
		● Ne pas incinérer les cartouches ni les boîtes de cartouches de toner.
		● Exposée à une flamme nue, la cendre de toner peut provoquer un retour de flamme.
		● Verbrennen Sie keinen Toner oder Tonerkartusche. Tonerstaub kann beim Kontakt mit offenem Feuer explodieren.
		● Non gettare il toner o i contenitori del toner sul fuoco. La polvere del toner si può incendiare dalla fiamma.
		● No incinerar el tóner ni los contenedores de tóner. El polvo de tóner puede inflamarse al ser expuesto al fuego.
		● Não exponha o Toner ou a sua embalagem ao fogo. O pó de Toner poderá explodir quando exposto a chama viva.
		● トナー又はトナーの入った容器を直接廃却炉等の火中に投入しないでください。火傷をするおそれがあります。

Do not incinerate toner or toner containers. Toner dust may cause flashback when exposed to open flames.

②



The inside of this printer becomes very hot. Do not touch parts with this label (indicating a hot surface). Touching these parts will result in burns.

③



The inside of this printer becomes very hot. Do not touch parts with this label (indicating a hot surface). Touching these parts will result in burns.

④

	CAUTION	PRECAUCIÓN		● High temperature.	● Alta temperatura.
	ACHTUNG	ATTENZIONE		● Hohe Temperatur.	● Temperatura elevada.
	ATTENTION	高温注意		● Température élevée.	● 高温になっています。

The inside of this printer becomes very hot. Do not touch parts with this label (indicating a hot surface). Touching these parts will result in burns.

ENERGY STAR Program

	<p>As an ENERGY STAR Partner, we have determined that this machine model meets the ENERGY STAR Guidelines for energy efficiency.</p>
---	--

The ENERGY STAR Guidelines intend to establish an international energy-saving system for developing and introducing energy-efficient office equipment to deal with environmental issues, such as global warming.

When a product meets the ENERGY STAR Guidelines for energy efficiency, the Partner shall place the ENERGY STAR logo onto the machine model.

This product was designed to reduce the environmental impact associated with office equipment by means of energy-saving features, such as Low-power mode.

❖ **Low-power Mode (Energy Saver mode)**

This printer automatically lowers its power consumption 15 minutes after the last operation has been completed. To exit Low-power (Energy Saver) mode, press any key on the control panel. For more information about how to configure Energy Saver mode, see “Making Printer Settings with Control Panel”, Software Guide as a HTML file on the CD-ROM.

❖ **Specifications**

Energy Saver mode	Power Consumption	With Options: 7.5 W or less Printer Only: 4.5 W
	Default Time	15 minutes

💡 **Recycled Paper**

In accordance with the ENERGY STAR Program, we recommend use of recycled paper which is environment friendly. Please contact your sales representative for recommended paper.

Manuals for This Printer

For particular functions, see the relevant parts of the manual.

❖ **Setup Guide (this manual)**

Provides information about printer setup and options.

❖ **Maintenance Guide**

Provides information about paper, replacing supplies, and dealing with paper jams and error messages.

❖ **Software Guide (HTML)**

Provides basic information about installing the printer driver and software, using the printer in a network environment, and configuration and setup.

Also, provides information about configuring and monitoring printer status using software and a Web browser.

 **Note**

Some functions cannot be used depending on your printer.

How to Read This Manual

The following set of symbols is used in this manual.

WARNING:

This symbol indicates a potentially hazardous situation that might result in death or serious injury when you misuse the machine without following the instructions under this symbol. Be sure to read the instructions, all of which are described in the Safety Information section.

CAUTION:

This symbol indicates a potentially hazardous situation that might result in minor or moderate injury or property damage that does not involve personal injury when you misuse the machine without following the instructions under this symbol. Be sure to read the instructions, all of which are described in the Safety Information section.

* The statements above are notes for your safety.

Important

If this instruction is not followed, paper might be misfed, originals might be damaged, or data might be lost. Be sure to read this.

Preparation

This symbol indicates information or preparations required prior to operating.

Note

This symbol indicates precautions for operation, or actions to take after abnormal operation.

Limitation

This symbol indicates numerical limits, functions that cannot be used together, or conditions in which a particular function cannot be used.

Reference

This symbol indicates a reference.

[]

Keys that appear on the machine's display.

Keys and buttons that appear on the computer's display.

[]

Keys built into the machine's control panel.

Keys on the computer's keyboard.

1. Guide to the Printer

Exterior

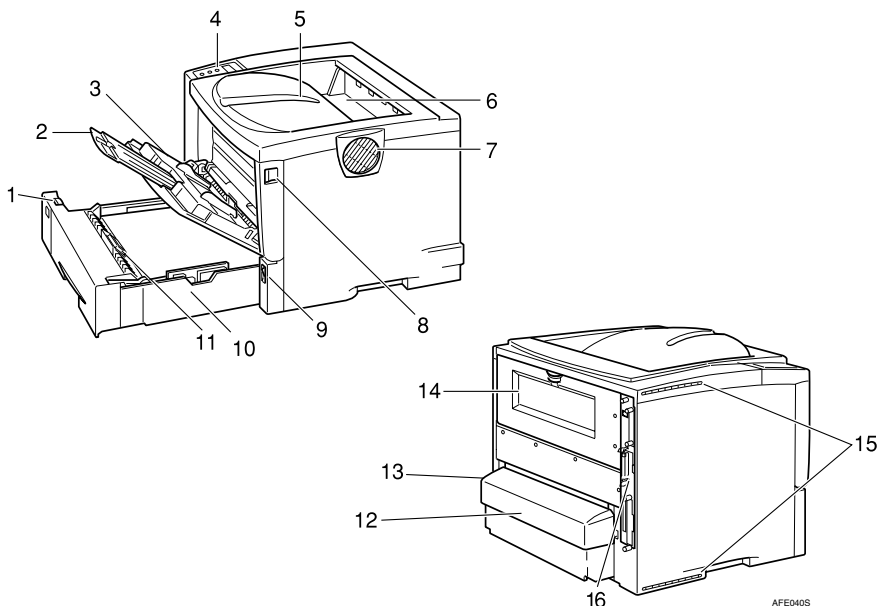

1. Paper Size Dial

Adjust this dial to match the size and feed direction of the paper loaded in the paper tray.

2. Bypass Tray Extension

Pull out this extension to load paper into the Bypass Tray when its length is longer than B5.

3. Bypass Tray

Use to print onto thick paper, OHP transparencies, adhesive labels, envelopes as well as plain paper. When printing on custom paper size, printer driver settings are required.

Up to 100 sheets of plain paper (80 g/m², 20 lb.) can be loaded.

See "Paper and Other Media Supported by this Printer" and "Loading Paper in the Bypass Tray", Maintenance Guide.

4. Control Panel

Contains keys for the printer operation and a panel display that shows the printer status.

5. Output Tray (Standard Tray)

Printed output is stacked here with the print side facing down.

6. Paper Exit Cover

Open this cover to remove misfed paper.

7. Ventilator

This hole helps to keep components inside the printer from overheating.

Important

- Do not block or obstruct the ventilator. A malfunction may occur due to overheating.

8. Front Cover Release Button

Use this button to open the front cover.

9. Power Switch

Use this switch to turn the printer power on and off.

10. Paper Tray (Tray 1)

Loads up to 500 sheets of plain paper (80 g/m², 20 lb.) into this tray for printing.

See “Paper and Other Media Supported by this Printer”, Maintenance Guide.

Note

- Paper Tray is displayed “Tray 1” on the display.

11. Friction pad

This is required to feed in paper one sheet at a time. Clean the friction pad when more than one sheet of paper is fed into the printer. Also, replace the friction pad when the message “Replace Maintenance Kit”, appears.

12. Paper Tray Cover

This is installed on the back of the printer.

13. Power Port

Connect the power cable to this port and the other end of the cable to the outlet.

14. Rear Cover

Remove to install the optional duplex unit or to replace the fusing unit.

15. Ventilators

These holes help to keep components inside the printer from overheating.

Important

- Do not block or obstruct the ventilators. A malfunction may occur due to overheating.

16. Controller Board

- Basic model printer:
Slide it out to install options such as the memory unit, network interface board, 1394 interface unit, 802.11b interface unit, Bluetooth interface unit or printer hard disk.
Plug cables such as the USB cable and parallel interface cable and into their connectors.
- Network standard model printer:
Slide it out to install options such as the memory unit, 1394 interface unit, 802.11b interface unit, Bluetooth interface unit or printer hard disk.
Plug cables such as the ethernet cable, USB cable and parallel interface cable and into their connectors.

Inside

[Front side]

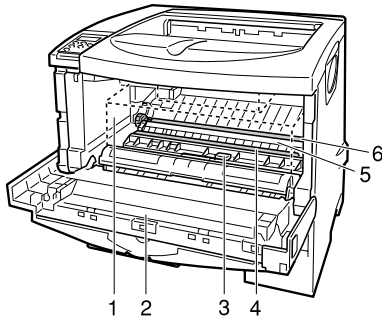

1. Toner Cartridge

Includes toner and a photo conductor unit.

When "Replace Toner Cartridge" appears on the panel display, replace this unit.

2. Front Cover

Open this cover when accessing the inside of the printer.

3. Guide Board

Open this board to remove misfed paper.

4. Registration Roller

Feeds the paper. If it becomes dirty, clean it.

See "Cleaning the Registration Roller", Maintenance Guide.

[Back side]

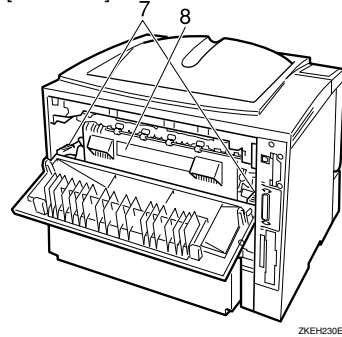

5. Transfer Roller Cover

Open this cover when replacing a transfer roller.

6. Transfer Roller

When "Replace Maintenance Kit" appears on the panel display, replace this roller.

7. Fusing Unit Lock Levers

Lift these levers when replacing the fusing unit.

8. Fusing Unit

Fuses the image onto paper.

When "Replace Maintenance Kit" appears on the panel display, replace this unit.

Control Panel

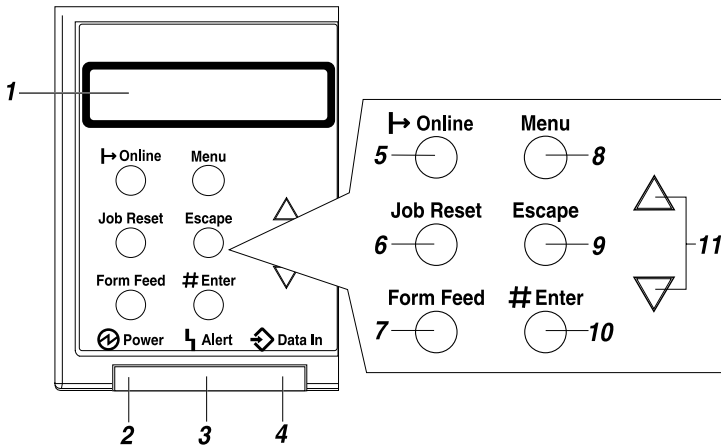

AFE602S

1. Display

Shows the current status of the printer and error messages.
See “Error & Status Messages on the Control Panel”, Maintenance Guide.

2. Power indicator

Is on while the printer power is on.
Is off when the power is turned off or while the printer is in Energy Saver mode.

3. Alert indicator

Blinks or lights up whenever any printer error occurs. A message describing the cause of the error also appears on the display.
See “Error & Status Messages on the Control Panel”, Maintenance Guide.

4. Data In indicator

Blinks when the printer is receiving data from a computer.
Is on if there is data to be printed.

5. [Online] key

Press this key to switch the printer between online and offline.

6. [Job Reset] key

When the printer is online, press this key to cancel any ongoing print job.
See “Canceling a Print job”, Software Guide.

7. [Form Feed] key

If the printer is offline, press this key to print all the data left in the printer’s input buffer.

Note

This does not work if the printer is online.

8. [Menu] key

Press this key to make and check the current printer settings.
See “Making Printer Settings Using the Control Panel”, Software Guide.

9. [Escape] key

Press this key to return to the previous condition on the display.

10. [# Enter] key

Press this key to execute menu items selected on the display.
Press this key to clear some errors.
See “Troubleshooting”, Maintenance Guide.

11. [▲][▼] keys

Use these keys to increase or decrease values on the display when making settings. Keep the key pressed to quicken scrolling, and increase or decrease values on the display in units of 10.

2. Setting Up

Where to Put the Printer

The printer's location should be carefully chosen because environmental conditions greatly affect its performance.

⚠ WARNING:

- ***Confirm the wall outlet is near the machine and freely accessible, so that in the event of emergency, it can be unplugged easily.***
- ***Only connect the machine to the power source described in the manual.***
- ***Avoid multi-wiring.***
- ***Do not damage, break or make any modifications to the power cord. Do not place heavy objects on it, pull it hard or bend it more than necessary. These actions could cause an electric shock or fire.***

⚠ WARNING:

- ***The supplied power cord is for use with this equipment only. Do not use with other appliances. Doing so may result in fire, electric shock, or injury.***

⚠ CAUTION:

- ***Do not handle the plug with wet hands. Doing so might cause an electrical shock.***
- ***Keep the machine in an area that is within optimum environmental conditions. Operating the machine in an environment that is outside the recommended ranges of humidity and temperature can cause an electrical fire hazard. Keep the area around the socket free of dust. Accumulated dust can become an electrical fire hazard.***
- ***Place the machine on a strong and level surface. Otherwise, it might fall and injure someone.***
- ***If you use the machine in a confined space, ensure there is continuous air circulation.***

❖ **Space Required for Installation**

Leave enough space around the printer. This space is necessary to operate the printer. The recommended (or minimum) space requirements are as follows:

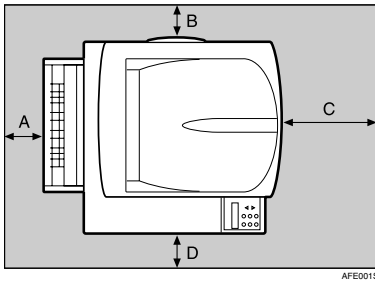

- A: 10 cm (4 inches) or more
- B: 10 cm (4 inches) or more
- C: 100 cm (39.4 inches) or more
- D: 10 cm (4 inches) or more

❖ **Optimum Environmental Conditions**

Permissible and recommended temperature and humidity ranges are as follows:

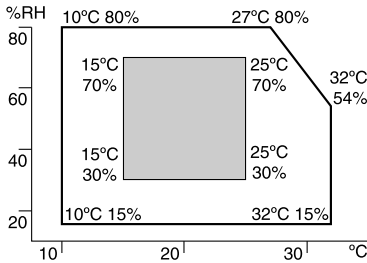

ZDJX006J

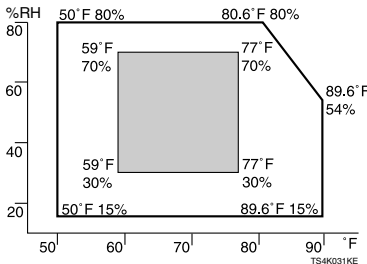

TS4K031KE

- White area: Permissible Range
- Gray area: Recommended Range

 **Note**

- The machine must be level within 5 mm, 0.2" from both front to rear and left to right.
- To avoid possible build-up of ozone, locate this machine in a large well ventilated room that has an air turnover of more than 30 m³/hr/person.
- When you use this machine for a long time in a confined space without good ventilation, you may detect an odd smell. To keep the workplace comfortable, we recommend you keep it well ventilated.

❖ Environments to Avoid **Important**

- Areas exposed to direct sunlight or strong light
- Dusty areas
- Areas with corrosive gases
- Areas that are excessively cold, hot, or humid
- Locations near air conditioners or humidifiers
- Locations near other electronic equipment
- Locations subject to frequent strong vibration

❖ Power Source

Connect the power cable to a power source of the following specification:

- 220 - 240 V, 50/60 Hz, 4.1 A or more

Unpacking the Printer and Checking the Contents of the Box

- 1** Check the contents of the box according to the following list. If one or some items are missing, please contact your sales or service representative.

Important

- The interface cable is not included in the box. Make sure that the interface cable you use, is appropriate for your computer.

❖ Manuals and CD-ROMs

- Setup Guide (This manual)
- Maintenance Guide
- CD-ROM "Printer Drivers and Utilities"
- CD-ROM "Display-Version Manuals (HTML)"
- CD-ROM "Print-Version Manuals (PDF)"

❖ Parts

- Power Cable
- Paper Tray Cover

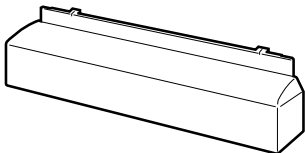

AFE002S

- Additional Documentation

- 2** Remove the plastic bag. Lift the printer and move it to the place where you want to install it.

When lifting the machine, use the inset grips on both sides. Otherwise the machine could break or cause injury if dropped.

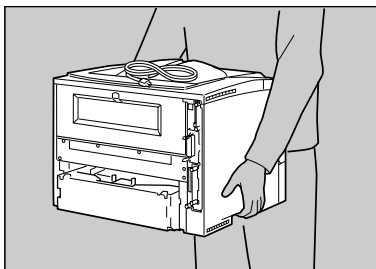

AFE700S

- 3** Remove the orange adhesive tape.

Important

- Lower the machine slowly and carefully to prevent trapping your hands.

Installing the Toner Cartridge

The following procedure describes how to install the toner cartridge.

WARNING:

- **Do not incinerate spilled toner or used toner. Toner dust is flammable and might ignite when exposed to an open flame.**
- **Disposal should take place at an authorized dealer or an appropriate collection site.**
- **If you dispose of the used toner cartridges yourself, dispose of them according to local regulations.**
- **Do not store toner, used toner, or toner containers in a place with an open flame. The toner might ignite and cause burns or a fire.**

CAUTION:

- *Keep toner (used or unused) and the toner containers out of reach of children.*
- *If toner or used toner is inhaled, gargle with plenty of water and move into a fresh air environment. Consult a doctor if necessary.*
- *If your skin comes into contact with toner or used toner, wash the affected area thoroughly with soap and water.*
- *If toner or used toner gets into your eyes, flush immediately with large amounts of water. Consult a doctor if necessary.*

CAUTION:

- *If toner or used toner is swallowed, dilute by drinking a large amount of water. Consult a doctor if necessary.*
- *Avoid getting toner on your clothes or skin when removing a paper jam or replacing toner. If your skin comes into contact with toner, wash the affected area thoroughly with soap and water.*
- *If toner gets on your clothing, wash with cold water. Hot water will set the toner into the fabric and may make removing the stain impossible.*
- *Our products are engineered to meet the highest standards of quality and functionality. When purchasing expendable supplies, we recommend using only those provided by an authorized dealer.*

Important

- Do not expose the toner cartridge to a light for a long time. If you do, the toner will be damaged and the print quality might be reduced.

Note

- The toner cartridges that comes with the printer will allow you to print up to about 3,000 pages. These numbers were obtained from printing A4  5% charts, but the actual number of pages will vary depending on the paper type, size, contents, and settings.
- Toner cartridges (consumable) are not covered by warranty. However, if there is problem, contact the store where they were purchased.

- 1** Open the front cover by pushing the front cover release button.

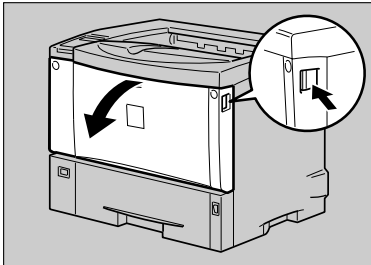

AFE004S

- 2** Remove the fixing material inserted between toner cartridge and the printer.

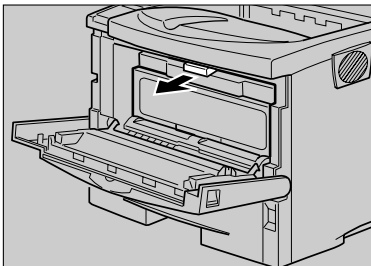

AFE005S

- 3** Lift the front side of the toner cartridge, and then pull it out of the printer.

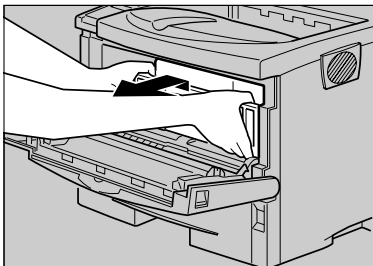

AFE006S

Note

- Do not hold the toner cartridge upside down or stand it vertically.
- Do not put the toner cartridge on an unstable or tilted surface.

- 4** Place the toner cartridge on a flat surface. Pull out the tape inside the unit horizontally while holding the cartridge with one hand as shown in the illustration.

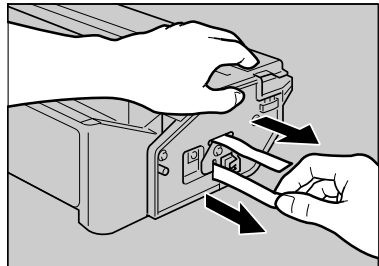

AFE007S

Important

- Be sure to remove the tape completely before installing the toner cartridge. Otherwise, the printer might be damaged.
- If you pull out the strips when the toner cartridge is slant or standing on its side, the cartridge might cause trouble with the printer.
- Be sure to pull the tape horizontally. Pulling it upward or downward may cause the toner to scatter.
- After pulling the tape out of the cartridge, toner scatters easily. Do not shake the cartridge.

- 5** Hold the grips of the toner cartridge, and then insert it into the printer until it stops.

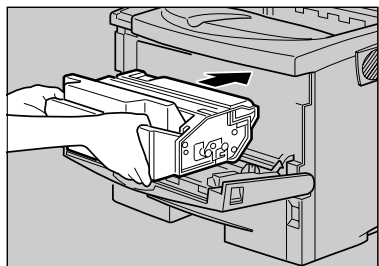

AFE008S

- 6** Insert the toner cartridge in its appropriate position by gently pushing down.

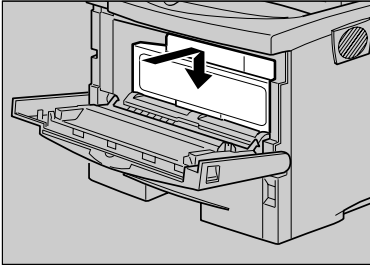

AFE009S

- 7** Close the front cover by pressing the indentations on the left and right sides.

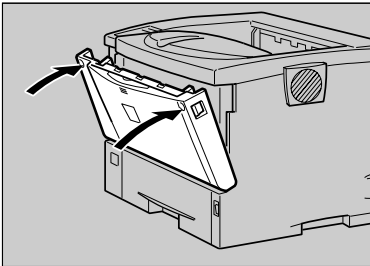

AFE010S

Important

- Do not close the front cover with force. If you cannot close the cover easily, pull out the toner cartridge from the printer and insert it again. After that, close the front cover again.
- Dispose of removed fixing material and tape in the same manner as ordinary plastic waste.

Loading Paper

The following describes how to load paper into the standard paper tray (Tray 1).

⚠ CAUTION:

- Do not pull out the paper tray forcefully. If you do, the tray might fall and cause an injury.

❗ Important

- To avoid paper jams, make sure paper is not stacked above the limit mark inside the tray. Misfeeds might occur.
- Do not mix different types of paper in a single paper tray.

1 Pull out the paper tray until it stops.

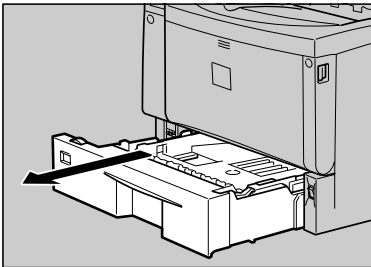

AFE0115

🔧 Note

- Do not touch the three white pins on the left front of the printer.

2 Lift the front side of the tray, and then pull it out of the printer.

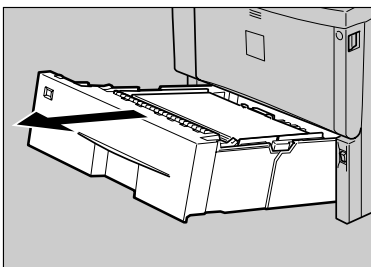

AFE0125

3 Load the new paper into paper tray with print side up.

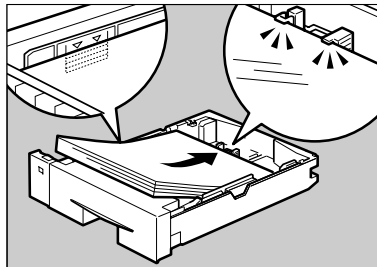

AFE0135

❗ Important

- Confirm that the top of the stack is not higher than the limit mark inside the tray.
- Confirm that the paper fits under the rear guide.

4 Carefully slide the paper tray into the printer until it stops.

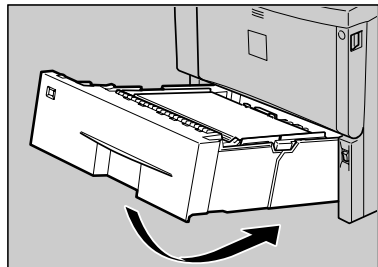

AFE0145

❗ Important

- Confirm that the setting of the paper size dial matches the sizes and feed direction of the paper in the tray. Otherwise, the printer might be damaged or a printing problem might occur.
- Do not slide the paper tray in and out with force. If you do, the front and side paper guides will move out the place.

Reference

For details about usable types of paper, see “Loading Paper”, Maintenance Guide.

- 5** Insert the paper tray aligning the ▼ mark on the back of the printer with the ▲ mark on the paper tray cover, and then push in the paper tray cover in the direction shown by the arrow in the illustration.

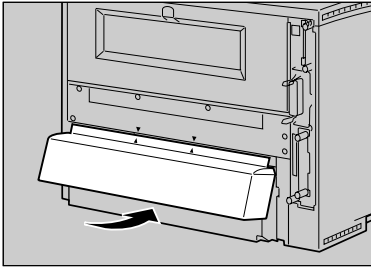

AFE015S

Note

- Do not install the paper tray cover if the duplex unit is installed.

Turning the Power On

Follow the procedure below to turn the power on.

⚠ WARNING:

- **Plug and unplug the power cable with dry hands, or an electric shock could occur.**

1 Make sure the power is set to “O” Off.

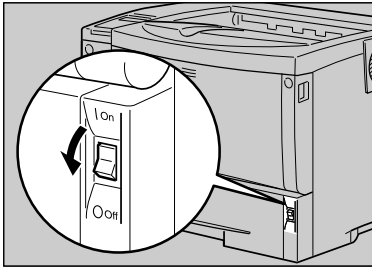

AFE016S

2 Plug in the power cable.

⚡ Important

- Make sure the power cable is plugged securely into the wall outlet.
- Turn the power off when plugging and unplugging the power plug.

3 Turn the power to “|” On.

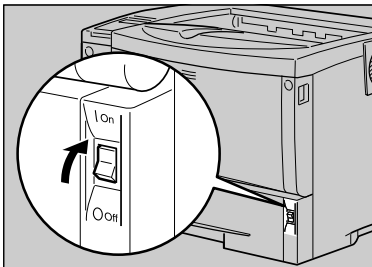

AFE017S

The power indicator on the control panel lights up.

Selecting the Display Language

Select a language using the procedure described here.

The message for the selected language will appear on the display. If you want to use the display in English, the following procedures are unnecessary.

Note

- The default setting is English.

1 Press the [Menu] key.

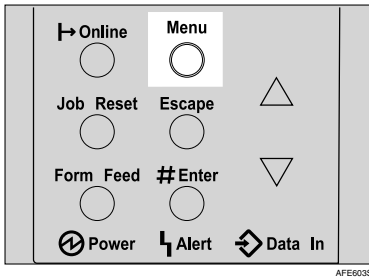

The [Menu] screen appears on the display.

2 Press the [▲] or [▼] key to display [Language].

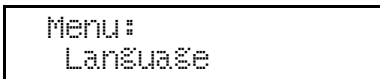

3 Press the [#Enter] key.

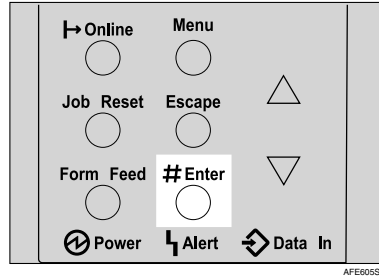

The following message appears on the display:

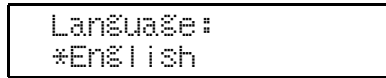

4 Press the [▲] or [▼] key until the language you want to select appears.

5 Press the [#Enter] key. Wait for two seconds.

The [Menu] screen appears on the display.

6 Press the [Online] key.

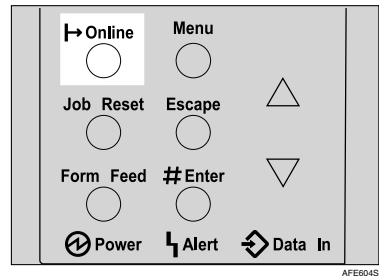

The initial screen appears.



Test Printing

The following explains the procedure for test printing of the configuration page.

Test print in order to verify that the printer is working normally. Test printing checks printer performance only; it does not test the connection to the computer.

1 Press the [Menu] key.

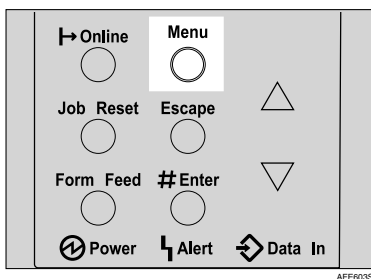

The [Menu] screen appears on the display.

2 Press the [▲] or [▼] key to display [List/Test Print], and then press the [# Enter] key.

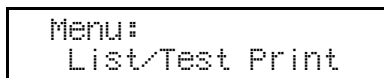

The menu for selecting the contents to be test printed appears.

3 Press the [▲] or [▼] key to display the [Config. Page], and then press the [# Enter] key.

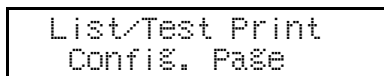

The following message appears and the configuration page is printed.

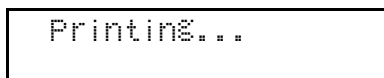

Note

- If printing is not normal, check to see if an error message appears on the display. If there is an error message, see "Troubleshooting", Maintenance Guide.

4 Check the options.

Note

- For details about the configuration page, see "Interpreting the Configuration Page", Software Guide.

5 Press the [Online] key.

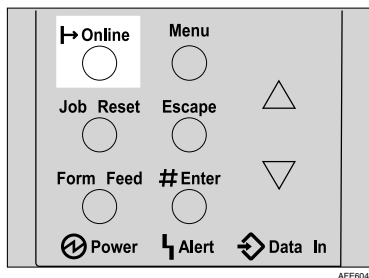

The initial screen appears.

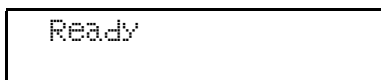

3. Installing Options

Available Options

This section describes how to install options.

By installing options, you can improve the printer performance and have an expanded variety of features to use. For the specifications of each option, see Maintenance Guide.

CAUTION:

- *Before installing options, the machine should be turned off and unplugged for at least an hour. Components inside the machine become very hot, and can cause a burn if touched.*
- *Before moving the machine, unplug the power cable from the outlet. If the cable is unplugged abruptly, it could become damaged. Damaged plugs or cables can cause an electrical or fire hazard.*
- *When lifting the machine, use the grips on both sides. The machine could break or cause an injury if dropped.*

Important

- The voltage rating of the connector for options is 24 V DC or less.

Option List

The following is a list of options for this printer. The network standard model come with the ethernet port on the controller board as default.

	Basic model Printer	Network standard model Printer
Paper Feed Unit Type 400	○	○
Envelope Feeder Type 400	○	○
AD450 (Duplex Unit)	○	○
Memory Unit Type C (SDRAM Module)	○	○
Hard Disk Drive Type 2600	○	○
Network Interface Board Type 2610 *1	○	-
1394 Interface Unit Type 4510 *1 *2	○	○
802.11b Interface Unit Type F *1 *2	○	○
Bluetooth Interface Unit Type C *1 *2	○	○
Network Data Protection Unit Type B	-	○

○: Available option

- : Unavailable option

*1 With Basic model, these cannot be installed at the same time.

*2 With Network standard model, these cannot be installed at the same time.

Option Installation Flow Chart

We recommend you install multiple options in the following order:

1 Attach the paper feed unit (Paper Feed Unit Type 400).

Attach the paper feed unit to the bottom of the printer.

You can attach up to two paper feed unit. Up to 1600 sheets of paper can be loaded.

2 Attach the envelope feeder (Envelope Feeder Type 400).

Replace the paper tray of the optional feeder with the envelope feeder.

3 Install the SDRAM module (Memory Unit Type C).

Install the module to the SDRAM module slot on the controller board.

4 Install the 1394 interface unit, network interface board, 802.11b interface unit or Bluetooth interface unit.

Install the 1394 interface unit, 802.11b interface unit or Bluetooth interface unit on the controller board.

The 1394 interface unit and network interface cannot be used at the same time.

Up to two of the following can be installed:

- Network Interface Board Type 2610
- 802.11b Interface Unit Type F
- 1394 Interface Unit Type 4510
- Bluetooth Interface Unit Type C

5 Install the hard disk drive (Hard Disk Drive Type 2600).

Install the hard disk drive to the controller board.

6 Install the Network Data Protection Unit Type B.

Insert the network data protection unit into the SD card slot on the controller board.

7 Attach the duplex unit (AD450).

Attach the duplex unit to the rear of the printer.

Installing Options

Install options in the positions shown in the illustration.

❖ Exterior

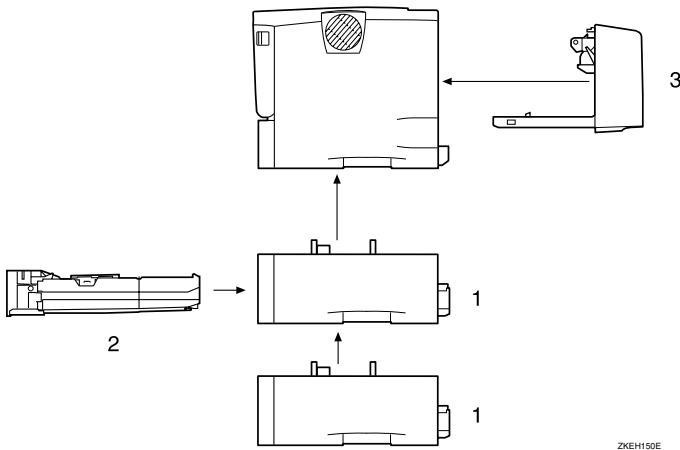

1. Paper Feed Unit Type 400 (Tray 2 or Tray 3)

You can load up to 500 sheets (60-105 g/m², 16-28 lb.) of plain paper into the tray.

See p.30 "Attaching Paper Feed Unit Type 400".

Note

- A maximum two Paper Feed Units Type 400 can be attached.
- Top-most optional paper feed unit is displayed "Tray 2" and bottom-most is displayed "Tray 3" on the display.

2. Envelope Feeder Type 400

You can load up to 60 envelopes (72-90 g/m², 19-24 lb.) into the tray.

See p.32 "Attaching Envelope Feeder Type 400".

Note

- The Envelope Feeder is a tray that slides into the optional paper feed unit. Without the optional paper feed unit, the Envelope Feeder cannot be used.
- Your printer can accommodate two optional paper feed units. The envelope feeder unit can be used in "Tray 2". Neither the main unit's feed tray (Tray 1) nor Tray 3 can be used for this purpose.

3. AD450 (duplex unit)

You can print on both sides of paper.

Install the duplex unit by removing the rear cover of the printer.

See p.52 "Attaching AD450 (Duplex Unit)".

❖ Basic model Printer : Interior

See the inside front cover of this manual to confirm which printer (Basic model or Network standard model) you have.

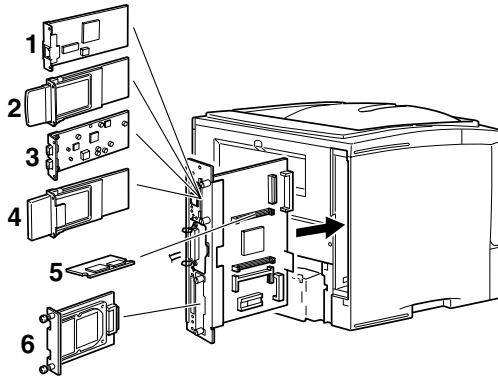

ZKEX010E

1. Network Interface Board Type 2610

See p.36 "Attaching Network Interface Board Type 2610".

2. 802.11b Interface Unit Type F

See p.42 "Attaching 802.11b Interface Unit Type F".

3. 1394 Interface Unit Type 4510

See p.39 "Attaching 1394 Interface Unit Type 4510".

4. Bluetooth Interface Unit Type C

See p.46 "Attaching Bluetooth Interface Unit Type C".

5. Memory Unit Type C (SDRAM Module)

See p.33 "Attaching Memory Unit Type C (SDRAM Module)".

6. Hard Disk Drive Type 2600

See p.50 "Attaching Hard Disk Drive Type 2600".

Note

- You can have one of the following types of extension board installed at the same time: Network Interface Board Type 2610, 802.11b Interface Unit Type F, 1394 Interface Unit Type 4510, Bluetooth Interface Unit Type C.

Reference

For the specifications of each option, see Maintenance Guide.

❖ Network standard model Printer : Interior

See the inside front cover of this manual to confirm which printer (Basic model or Network standard model) you have.

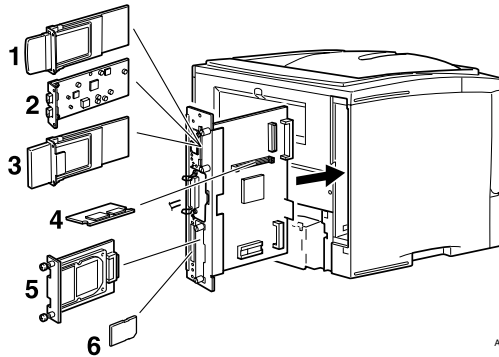

AFE019S

1. 802.11b Interface Unit Type F

See p.42 “Attaching 802.11b Interface Unit Type F”.

2. 1394 Interface Unit Type 4510

See p.39 “Attaching 1394 Interface Unit Type 4510”.

3. Bluetooth Interface Unit Type C

See p.46 “Attaching Bluetooth Interface Unit Type C”.

4. Memory Unit Type C (SDRAM Module)

See p.33 “Attaching Memory Unit Type C (SDRAM Module)”.

5. Hard Disk Drive Type 2600

See p.50 “Attaching Hard Disk Drive Type 2600”.

6. Network Data Protection Unit Type B

See p.51 “Attaching Network Data Protection Unit Type B”.

Note

- You can have one of the following types of extension board installed at the same time: 802.11b Interface Unit Type F, 1394 Interface Unit Type 4510, Bluetooth Interface Unit Type C.

Reference

For the specifications of each option, see Maintenance Guide.

Attaching Paper Feed Unit Type 400

Preparation

When installing multiple options, install the paper feed unit first.

CAUTION:

- *The printer weighs about 17 kg (37.5 lb.). When lifting the machine, use the inset grips on both sides. Otherwise the printer could break or cause injury if dropped.*

Important

- Do not slide more than one paper tray out at the same time. Having more than one full paper tray fully extended could cause the machine to topple.
- More than two paper feed units cannot be attached.
- Check the printer nameplate to confirm the model code.

1 Check the package contains the following:

- ❖ Paper Feed Unit (including a paper tray)

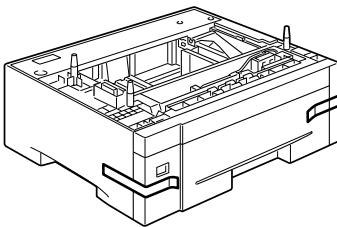

ZKDX210J

2 Turn off the power of the printer, and then unplug the printer's power cable and the interface cable.

3 Remove the adhesive tape from the paper feed unit.

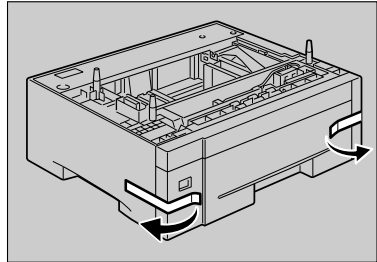

ZKDX390J

Note

- If you attach two paper feed units at the same time, stack them up in advance.

4 There are three pins on the top of the paper feed unit that point straight up. On the bottom of the printer there are three holes. Align the holes over the pins, and then lower the printer gently onto the paper feed unit.

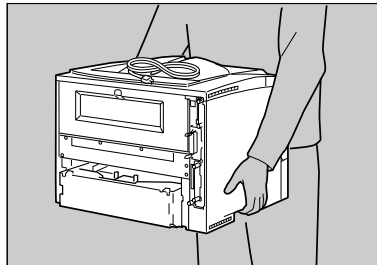

AFE700S

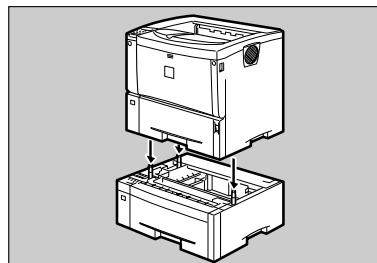

ZKEX400E

- 5** Attach the interface cable to the printer.
- 6** Plug the printer's power cord back into the wall outlet, and then turn on the power.

 **Note**

- After finishing installation, you can check whether the paper feed unit is properly installed: Print the configuration page from the "List/Test Print" menu. If it is installed properly, you will see "Paper Feed Unit (Tray 2)" or "Paper Feed Unit (Tray 2), Paper Feed Unit (Tray 3)" under the "Options" list.
- If the paper feed unit is not installed properly, reinstall it from the start. If you cannot install it properly even after attempting reinstallation, contact your sales or service representative.

 **Reference**

For printing the configuration page, see p.24 "Test Printing".

See "Loading Paper", Maintenance Guide.

When adjusting the printing position, see "Adjusting Tray Registration", Maintenance Guide.

Attaching Envelope Feeder Type 400

Note

- ❑ This unit is a tray that slides into the optional paper feed unit. Without the optional paper feed unit, this Envelope Feeder cannot be used.
- ❑ Your printer can accommodate two optional paper feed units. The envelope feeder unit can be used in "Tray 2". Neither the main unit's feed tray (Tray 1) nor Tray 3 can be used for this purpose.

Important

- ❑ Do not slide more than one paper tray out at the same time. Having more than one full paper tray fully extended could cause the machine to topple.

The following explanation uses the example of installing the envelope feeder unit in "Tray 2".

- 1** Check the package contains the following:

❖ Envelope Feeder

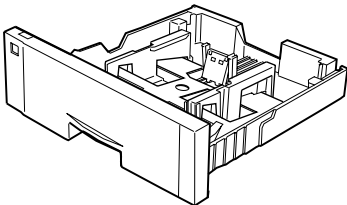

AFE441S

- 2** Pull out the second paper tray (Tray 2) of the optional paper feed unit until it stops. After that, lift it slightly, and then pull it out.

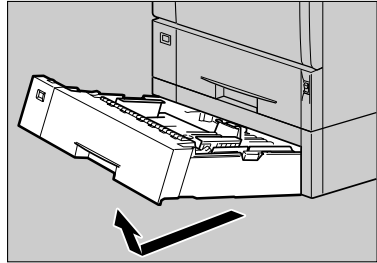

ZKEP330E

Important

- ❑ The envelope feeder must be used in the top-most optional paper feed unit (Tray 2).
- ❑ The tray of the top-most optional paper feed unit is beneath the paper tray.

Note

- ❑ Keep the paper tray with paper in a cool dark place.

- 3** Lift the front of the envelope feeder, and slide it carefully into the printer until it stops.

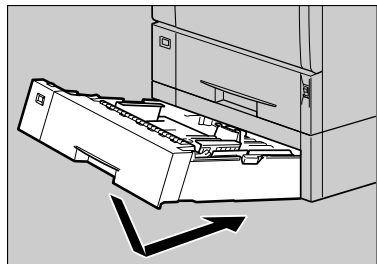

ZKEP340E

Reference

For information about loading paper, see "Loading Envelopes", Maintenance Guide.

Attaching Memory Unit Type C (SDRAM Module)

⚠ CAUTION:

- Do not touch the inside of the controller board compartment. Doing so may cause a malfunction or a burn.

⚡ Important

- Before touching the memory unit, ground yourself by touching something metal to discharge any static electricity. Static electricity can damage the memory unit.
- Do not subject the memory unit to physical shocks.
- If a printer hard disk is already installed, temporarily remove it and insert the memory unit. Reinstall the printer hard disk after inserting the memory unit.
- Before using the new memory unit, you must make settings in the printer driver.

🔧 Note

- Available memory varies depending on model type.
 - Basic model printer: Install the SDRAM module to the SDRAM module slot on the controller board. There are three types of Memory Unit: 64 MB, 128 MB and 256 MB.

Standard	Extended	Total
64 MB	64 MB	128 MB
	128 MB	192 MB
	256 MB	320 MB

- Network standard model printer: The default SDRAM module (128 MB) is installed. To expand memory, remove the default SDRAM module, and then install the SDRAM module (256 MB). "Total Memory" will be the size of SDRAM module memory unit you installed.

- 1** Turn off the power of the printer, and then unplug the printer's power cable and the interface cable.
- 2** Remove the two screws holding the controller board in place.

🔧 Note

- Use a coin or similar object if the screws do not turn easily.
- The removed screws are required in fastening the controller board.

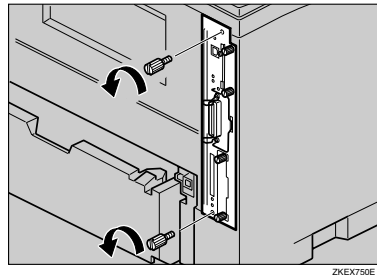

- 3** Pull out the handle of the controller board.

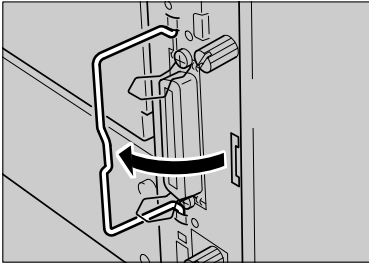

- 4** Pull the handle, and then slide the controller board out.

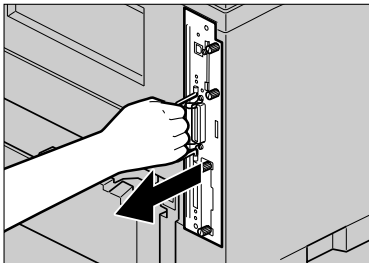

- 5** Place the controller board on a flat surface.

- 6** The Memory Unit is installed in the slot shown in the illustration below.

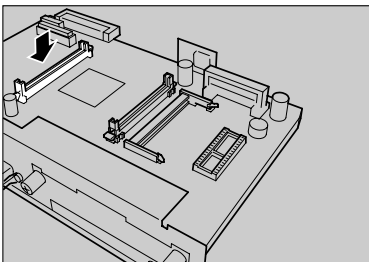

Note

- For network standard model printer, the default SDRAM module (128 MB) is installed.

- 7** For basic model printer, install the SDRAM module in a vacant slot. Align the notch of the SDRAM module to the slot, and then push it down until it clicks.

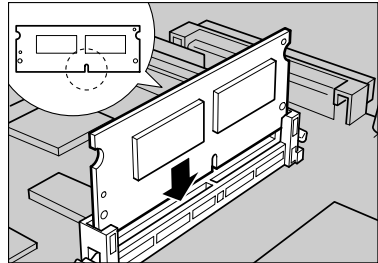

- 8** For network standard model printer, remove the default SDRAM module before installing a new SDRAM module. Press down the levers on both sides to remove the default memory unit.

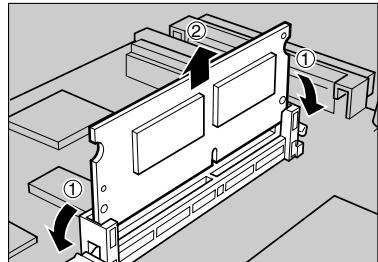

Align the notch of the SDRAM module to the slot, and then push it down until it clicks.

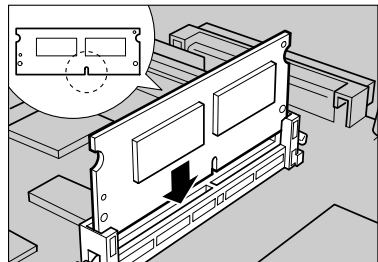

- 9** Match the controller board to the top and bottom rail using the “▼” mark, and then slide it into the printer slowly until it stops.

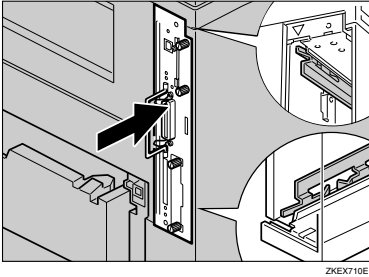

- 10** Push the handle of the controller board until it clicks.

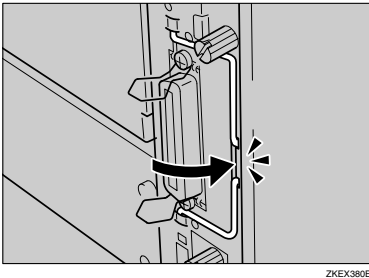

- 11** Fasten the controller board to the printer with the two screws.

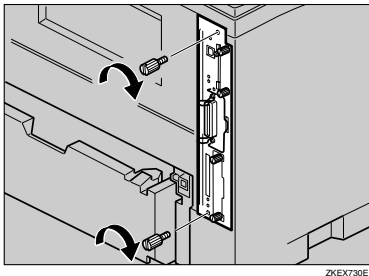

Note

- Be sure to return the provided screwdriver to its original position on the inside of the front cover.
- After finishing the installation, you can check the memory unit is properly installed: Print the configuration page from the “List/Test Print” menu. If it is installed properly, you will see the memory capacity for “Total Memory”.
- For basic model printer, “Total Memory” will be the total size of the standard SDRAM and the SDRAM memory unit you installed. For network standard model printer, “Total Memory” will be the size of SDRAM module memory unit you installed.
- If the memory unit is not properly installed, repeat the procedure from the start. If you cannot install it properly even after reinstallation, contact your sales or service representative.

Reference

For printing the configuration page, see p.24 “Test Printing”.

Attaching Network Interface Board Type 2610

This option is for basic model printer.

⚠ CAUTION:

- Do not touch the inside of the controller board compartment. Doing so may cause a malfunction or a burn.

⚡ Important

- ❑ Before touching the network interface board, touch something metal to discharge any static electricity. Static electricity can damage the network interface board.
- ❑ Do not subject the network interface board to physical shocks.
- ❑ Use the shielded twisted-pair (STP) network interface cable.

1 Check the package contains the following:

- ❖ Network Interface Board Type 2610

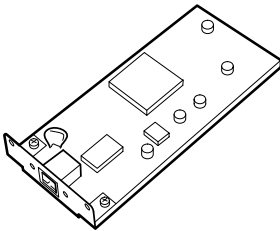

ZKDX290J

- ❖ Ferrite Core

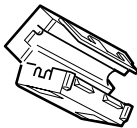

ZKDX300J

2 Turn off the power of the printer, and then unplug the printer's power cable and the interface cable.

3 Remove the two screws holding the controller board in place.

🔧 Note

- ❑ Use a coin or similar object if the screws do not turn easily.
- ❑ The removed screws are required in fastening the controller board.

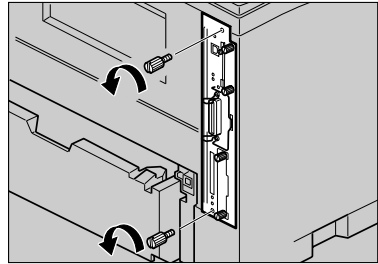

ZKEX750E

4 Pull out the handle of the controller board.

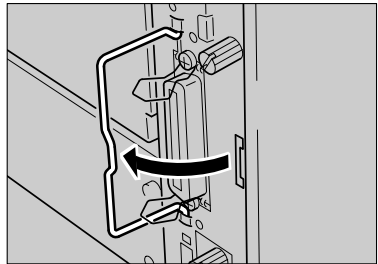

ZKEX370E

5 Holding the handle, slowly pull out the controller board.

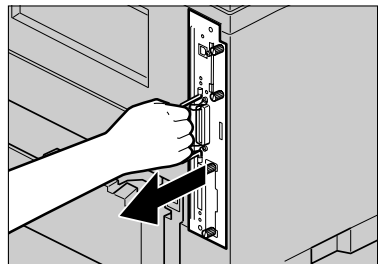

ZKEX720E

6 Place the controller board on a flat surface.

7 Remove the two screws and the cover of the network interface board mounting bracket.

 **Note**

- These screws are used again in fastening the interface unit to the controller board.
- The removed cover is not used when installing the network interface board.

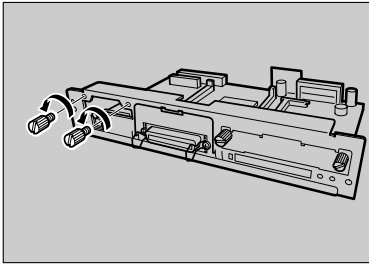

ZKEX041E

8 Attach the network interface board to the controller board.

Insert the end of the network interface board into the opening (①), and then push down until it clicks (②).

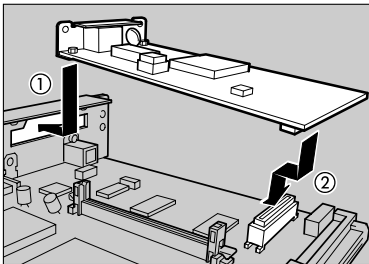

ZKEX422E

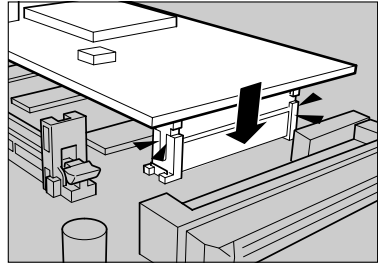

ZKEX432E

9 Fasten the network interface board to the controller board.

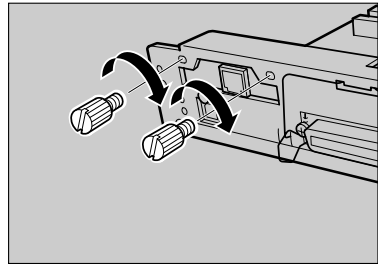

ZKEX444E

10 Match the controller board to the top and bottom rail using the “▼” mark, and then slide it into the printer slowly until it stops.

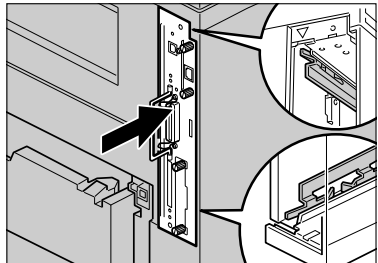

ZKEX254E

- 11** Push back the handle of the controller board until it clicks.

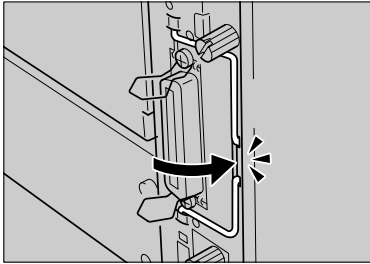

- 12** Fasten the controller board to the printer with the two screws.

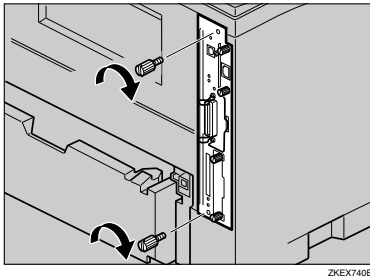

 **Note**

- After finishing installation, you can check the network interface board is properly installed: Print the configuration page from the “List/Test Print” menu. If it is installed properly, you will see “Option Ethernet Board” for “Controller Option”.
- If the Network interface board is not installed properly, repeat the procedure from the start. If you cannot install it properly even after reinstallation, contact your sales or service representative.

 **Reference**

For printing the configuration page, see p.24 “Test Printing”.

Attaching 1394 Interface Unit Type 4510

⚠ CAUTION:

- Do not touch the inside of the controller board compartment. Doing so may cause a malfunction or a burn.

🔧 Important

- ❑ The 1394 interface unit uses “IP over 1394” and “SCSI print”. Operating system-compatible connection methods are as follows (IEEE 1394 cannot be used with Windows 95/98 and Windows NT 4.0):
 - Windows Me
“IP over 1394”
 - Windows 2000
“SCSI print”
 - Windows XP, Windows Server 2003
“IP over 1394”, “SCSI print”
- ❑ Under Windows 2000, the 1394 interface unit can only be used with Service Pack 1 or later. The client cannot install the printer driver without using an account that has administrators access rights.
- ❑ Before touching the 1394 interface unit, ground yourself by touching something metal to discharge any static electricity. Static electricity can damage the 1394 interface unit.
- ❑ Do not plug or unplug the 1394 interface cable while installing the printer driver.
- ❑ Use the 1394 interface cable that comes with 1394 interface unit.

- 1** Check the package contains the following:

- ❖ 1394 Interface Unit Type 4510

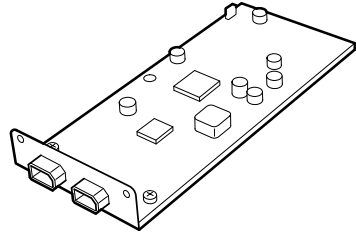

ZKDP400J

- ❖ 1394 Interface Cable (6 pins x 4 pins)



ZKDP993J

- ❖ 1394 Interface Cable (6 pins x 6 pins)

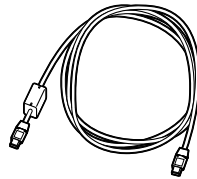

ZKDP992J

- 2** Turn off the power of the printer, and then unplug the printer's power cable and the interface cable.

- 3** Remove the two screws holding the controller board in place.

Note

- Use a coin or similar object if the screws do not turn easily.
- These screws are used again in fastening the controller board.

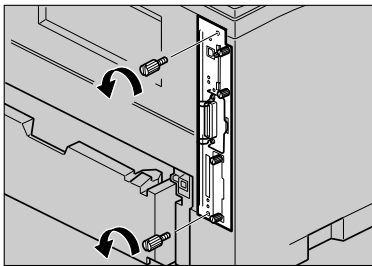

ZKEX750E

- 4** Pull out the handle of the controller board.

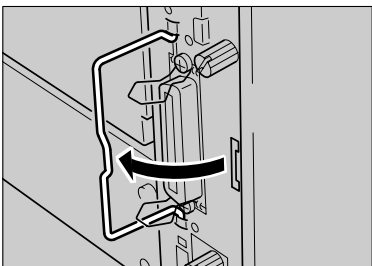

ZKEX370E

- 5** Pull the handle, and then slide the controller board out.

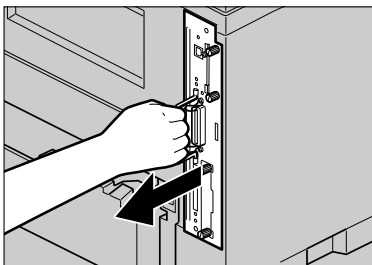

ZKEX720E

- 6** Place the controller board on a flat surface.

- 7** Remove the two screws and the cover of the 1394 interface unit mounting bracket.

Note

- These screws are used again in fastening the 1394 interface unit to the controller board.
- The removed cover is not used when installing the 1394 interface unit.

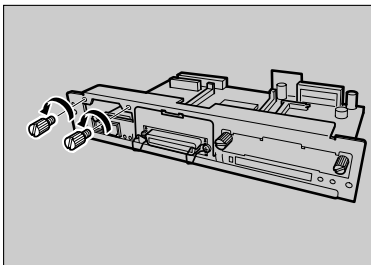

ZKEX040E

- 8** Attach the 1394 interface unit to the controller board.

Insert the end of the 1394 interface unit into the opening (1), and then push down until it clicks (2).

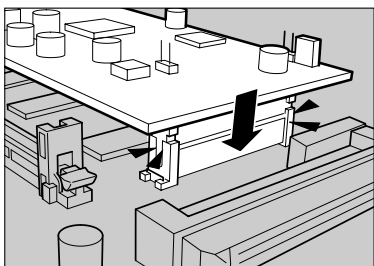

ZKEX430E

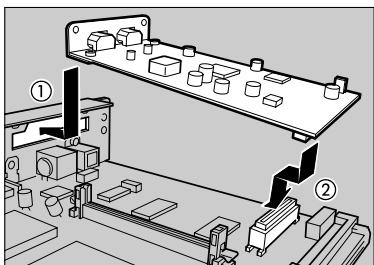

ZKEX421E

- 9** Fasten the 1394 interface unit to the controller board.

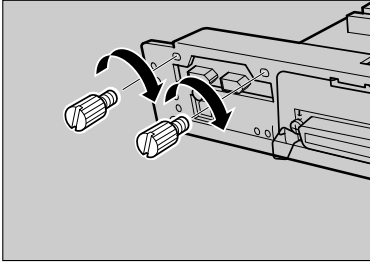

ZKEX443E

- 12** Fasten the controller board to the printer with the two screws.

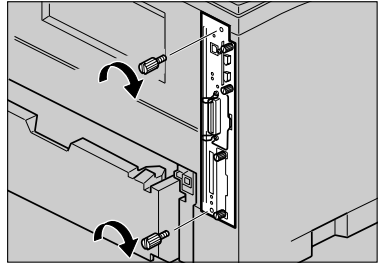

ZKEX272E

- 10** Match the controller board to the top and bottom rail using the “▼” mark, and then slide it into the printer slowly until it stops.

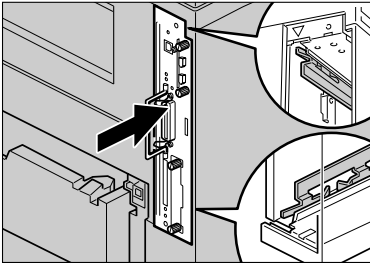

ZKEX259E

- 11** Push back the handle of the controller board until it clicks.

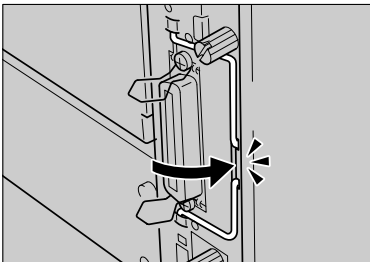

ZKEX389E

Note

- After finishing installation, you can check the 1394 interface unit is properly installed: Print the configuration page from the “List/Test Print” menu. If it is installed properly, you will see “IEEE1394” for “Controller Option”.
- You need to make settings with the control panel before using the 1394 interface unit. For more information, see p.68 “IEEE 1394 Configuration”.
- If the 1394 interface unit is not installed properly, repeat the procedure from the start. If you cannot install it properly even after reinstallation, contact your sales or service representative.

Reference

For printing the configuration page, see p.24 “Test Printing”.

Attaching 802.11b Interface Unit Type F

⚠ CAUTION:

- Do not touch the inside of the controller board compartment. Doing so may cause a machine malfunction or a burn.

⚡ Important

- Before touching the 802.11b interface unit, touch something metal to discharge any static electricity. Static electricity can damage the 802.11b interface unit.
- Do not subject the 802.11b interface unit to physical shocks.

1 Check the package contains the following:

❖ 802.11b Interface Unit Type F

- Interface Unit

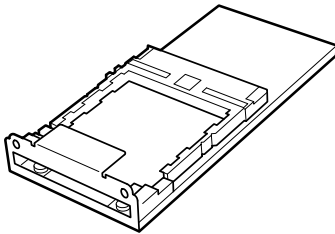

ZKDP410J

- Card

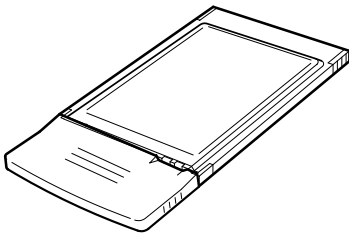

ZKDX290J

- Antenna Cap



ZKDP900J

2 Turn off the power of the printer, and then unplug the printer's power cable and the interface cable.

3 Remove the two screws holding the controller board in place.

🔧 Note

- Use a coin or similar object if the screws do not turn easily.
- These screws are used again in fastening the controller board.

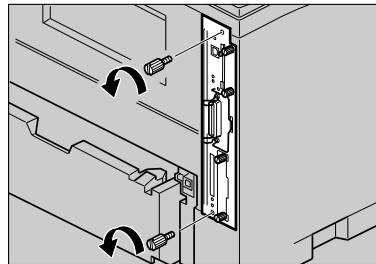

ZKEX750E

4 Pull out the handle of the controller board.

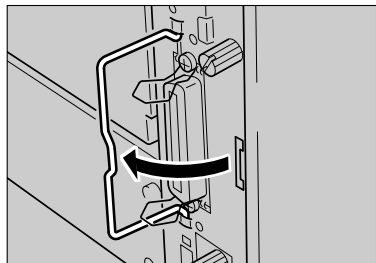

ZKEX370E

- 5** Pull the handle, and then slide the controller board out.

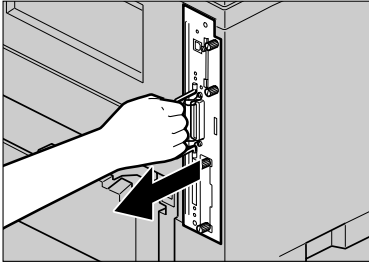

ZKEX720E

- 6** Place the controller board on a flat surface.

- 7** Remove the two screws and the cover of the 802.11b interface unit mounting bracket.

 **Note**

- These screws are used again in fastening the 802.11b interface unit to the controller board.
- The removed cover is not used when installing the 802.11b interface unit.

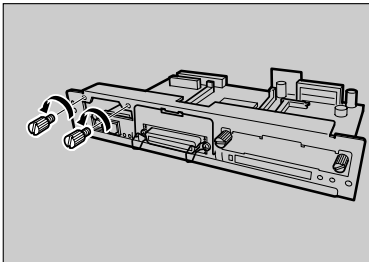

ZKEX040E

- 8** Attach the 802.11b interface unit.

Insert the end of the 802.11b interface unit into the opening (①), and then push down until it clicks (②).

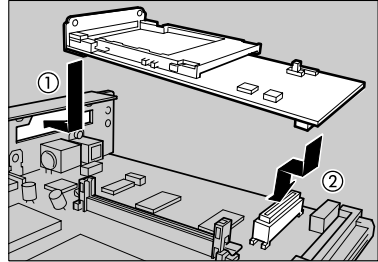

ZKEX420E

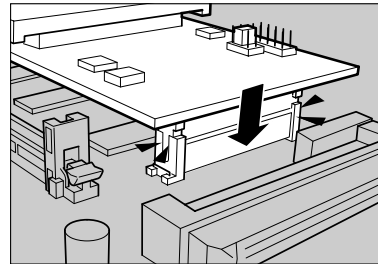

ZKEX431E

- 9** Fasten the 802.11b interface unit to the controller board with the two screws.

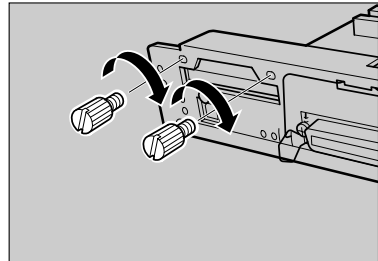

ZKEX442E

- 10** Insert the card slowly into the interface unit with the label facing down and the uneven black antenna surface facing up until it stops.

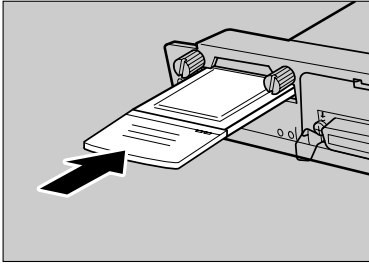

ZKEX500E

- 11** Match the controller board to the top and bottom rail using the “▼” mark, and then slide it into the printer slowly until it stops.

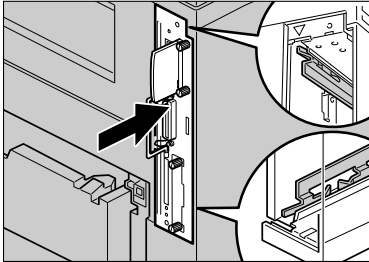

ZKEX251E

- 12** Push back the handle of the controller board until it clicks.

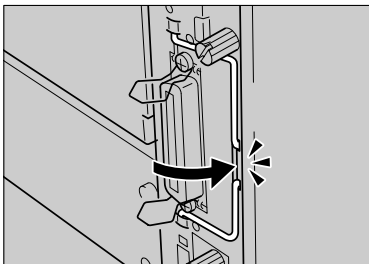

ZKEX380E

- 13** Fasten the controller board to the printer with the two screws.

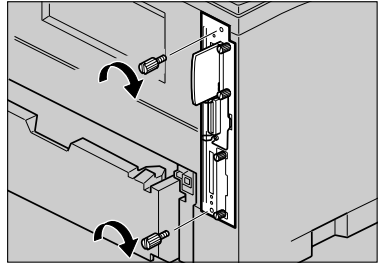

ZKEX273E

- 14** Attach the antenna cap to the card with the side that has both corners of the antenna cap cut out facing the screws.

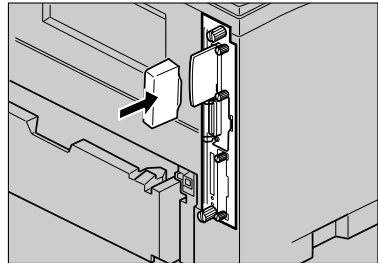

ZKEX275E

Note

- After finishing installation, you can check the 802.11b interface unit is properly installed: Print the configuration page from the “List/Test Print” menu. If it is installed properly, you will see “IEEE 802.11b” for “Controller Option”.
- If the 802.11b interface unit is not installed properly, repeat the procedure from the start. If you cannot install it properly even after reinstallation, contact your sales or service representative.

- ❑ You need to make settings with the control panel before using the 802.11b interface unit. For more information, see p.64 "IEEE 802.11b (Wireless LAN) Configuration".

 **Reference**

For printing the configuration page, see p.24 "Test Printing".

Attaching Bluetooth Interface Unit Type C

⚠ CAUTION:

- Do not touch inside the controller board compartment. Doing so may cause a machine malfunction or a burn.

⚡ Important

- ❑ When using the printer with the Bluetooth interface unit installed, Bluetooth needs to be installed on the computer.
- ❑ Before touching the Bluetooth interface unit, touch something metal to discharge any static electricity. Static electricity can damage the Bluetooth interface unit.
- ❑ Do not subject the Bluetooth interface unit to physical shocks.

1 Check the package contains the following:

- ❖ Bluetooth Interface Unit Type C
 - Interface Unit

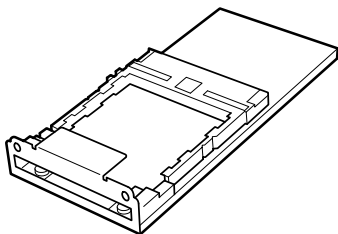

ZKDP410J

- Card

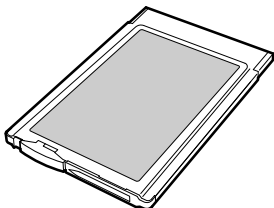

ZKDP510J

- Antenna Cap



ZKDP900J

2 Turn off the power, and then unplug the interface cable.

3 Remove the two screws holding the controller board in place.

🔧 Note

- ❑ Use a coin or similar object if the screws do not turn easily.
- ❑ These screws are used again in fastening the controller board.

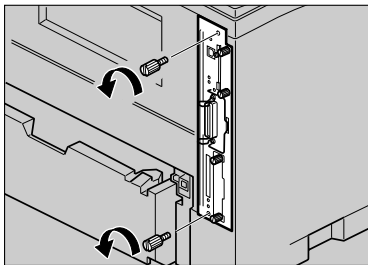

ZKEX750E

4 Pull out the handle of the controller board.

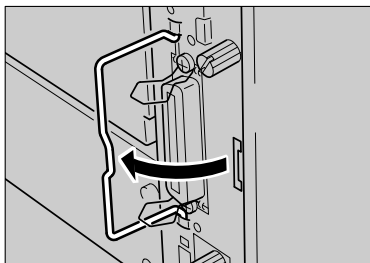

ZKEX370E

- 5** Pull the handle, and then slide the controller board out.

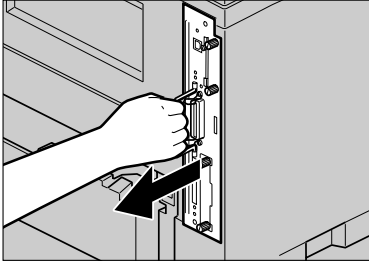

ZKEX720E

- 6** Place the controller board on a flat surface.

- 7** Remove the two screws and the cover of the Bluetooth interface Unit mounting bracket.

 **Note**

- These screws are used again in fastening the Bluetooth interface unit to the controller board.
- The removed cover is not used when installing the Bluetooth interface unit.

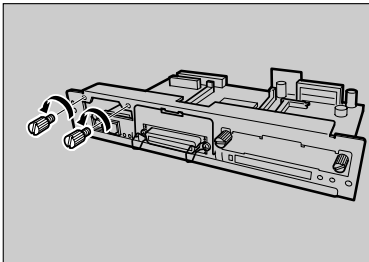

ZKEX040E

- 8** Attach the Bluetooth interface unit.

Insert the end of the Bluetooth interface unit into the opening (①), and then push down until it clicks (②).

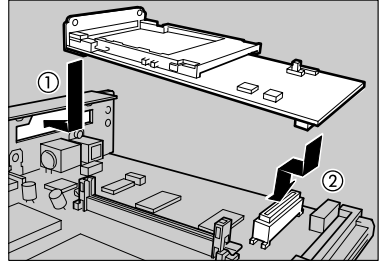

ZKEX420E

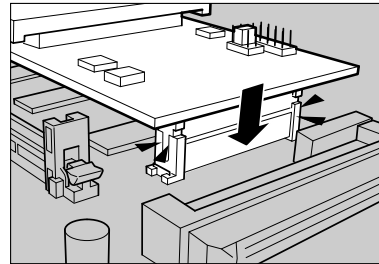

ZKEX431E

- 9** Fasten the Bluetooth interface unit to the controller board with the two screws.

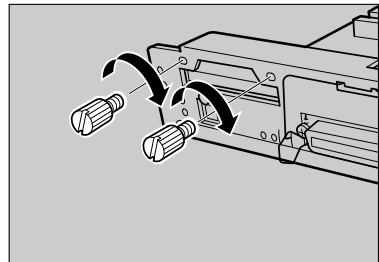

ZKEX442E

- 10** With the side labeled INSERT facing up, slowly insert the card into the interface unit, until it stops.

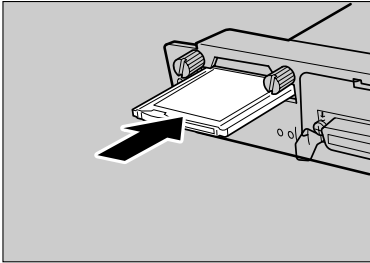

ZKEX070E

- 11** Match the controller board to the top and bottom rail using the "▼" mark, and then slide it into the printer slowly until it stops.

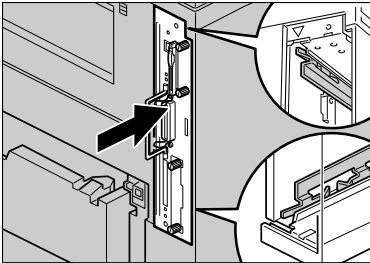

ZKEX080E

- 12** Push back the handle of the controller board until it clicks.

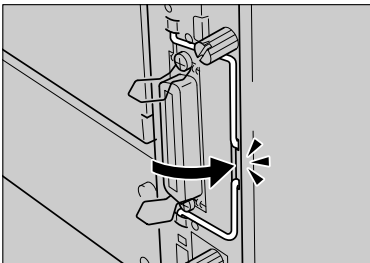

ZKEX380E

- 13** Fasten the controller board to the printer with the two screws.

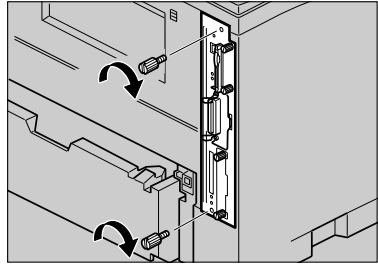

ZKEX274E

- 14** Press the antenna to extend it.

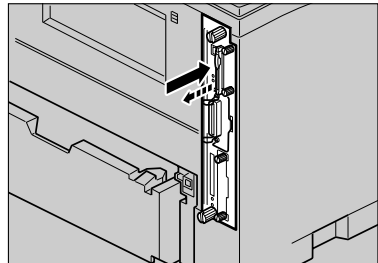

ZKEX090E

- 15** Attach the antenna cap to the card with the side that has both corners of the antenna are cut out facing the screws.

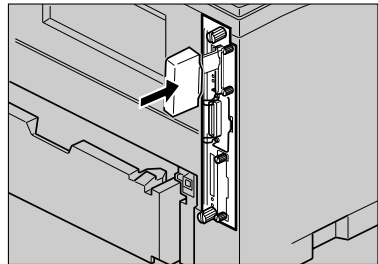

ZKEX340E

 **Note**

- ❑ After finishing installation, you can check the Bluetooth interface unit is properly installed: Print the configuration page from the “List/Test Print” menu. If it is installed properly, you will see “Bluetooth” for “Controller Option”.
- ❑ If the Bluetooth interface unit is not installed properly, repeat the procedure from the start. If you cannot install it properly even after reinstallation, contact your sales or service representative.

 **Reference**

For printing the configuration page, see p.24 “Test Printing”.

Attaching Hard Disk Drive Type 2600

⚠ Important

- ❑ Before touching the Hard Disk Drive, touch something metal to discharge any static electricity. Static electricity can damage the Hard Disk Drive.

1 Check the package contains the following:

- ❖ Hard Disk Drive Type 2600

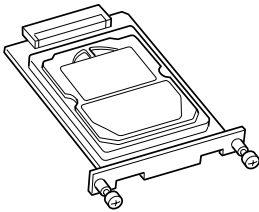

2 Turn off the power of the printer, and then unplug the power cable.

3 Remove the two screws and the cover of the hard disk drive mounting bracket.

🔧 Note

- ❑ Use a coin or similar object if the screws do not turn easily.
- ❑ The screws and cover are not used when installing the hard disk drive.

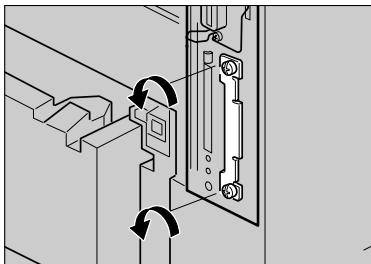

4 Slowly insert the hard disk drive while aligning it with the top and bottom rails in the printer until it stops.

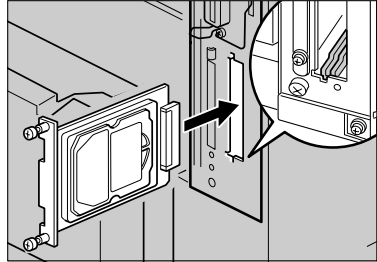

5 Fasten the two screws (using a coin, etc.) to fix the hard disk drive.

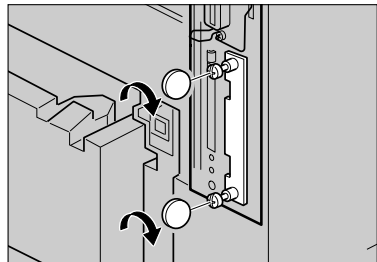

🔧 Note

- ❑ After finishing installation, you can check whether the hard disk drive is properly installed: Print the configuration page from the "List/Test Print" menu. If it is installed properly, you will see "Printer Hard Disk Drive" for "Controller Option".
- ❑ If the Hard disk drive is not installed properly, repeat the procedure from the start. If you cannot install it properly even after reinstallation, contact your sales or service representative.

🔍 Reference

For printing the configuration page, see p.24 "Test Printing".

Attaching Network Data Protection Unit Type B

Important

- Protect the network data protection unit from physical shocks.

Note

- Use the under slot for the data protection unit.

- 1** Check the package contains the following:

- ❖ Network Data Protection Unit Type B

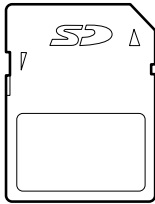

AET104S

- 2** Turn off the power of the printer, and then unplug the power cable.

- 3** Remove the card slot cover at the back of the printer.

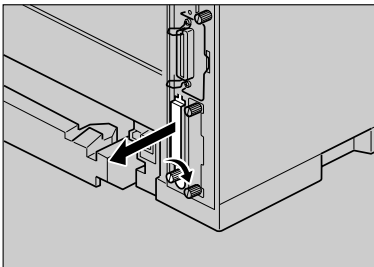

AFE031S

- 4** Carefully insert the network data protection unit, until the card clicks into the place.

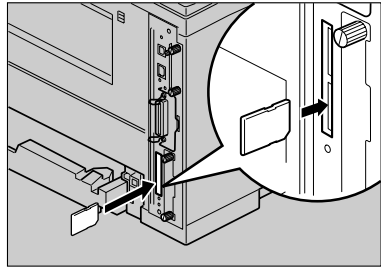

AFE032S

- 5** Reattach the cover over the network data protection unit. Fasten the screw to secure the cover.

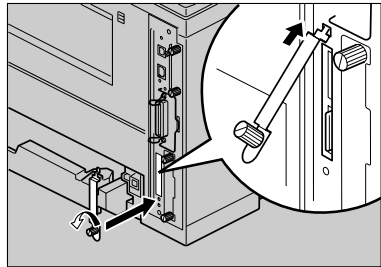

AFE033S

Note

- Do not touch the network data protection unit while the machine is in use. It may come loose, even if pushed only slightly.

Attaching AD450 (Duplex Unit)

Important

- ❑ If you attach the duplex unit and the paper feed unit, the paper feed unit must be attached prior to attaching the duplex unit.
- ❑ Check the printer nameplate to confirm the model code.

1 Check the contents of the box for the following items:

- ❖ AD450 (Duplex Unit)

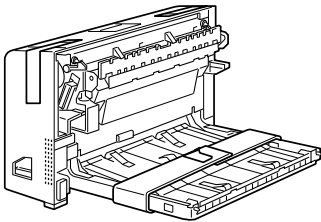

ZKDX310J

2 Turn off the power of the printer, and then unplug the power cable.

3 Remove the adhesive tape and paper.

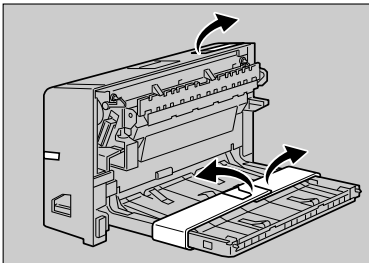

ZKEX850E

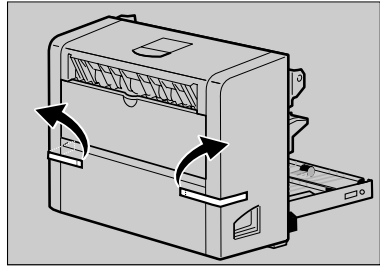

ZKEX651E

4 Place a finger in the printer's rear cover finger-hole (upper center) and pull it open.

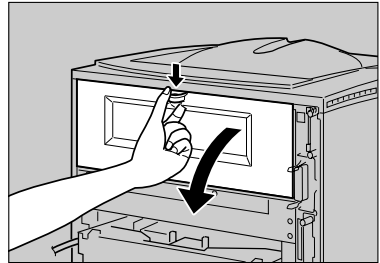

AFE041S

5 Remove the rear cover in the horizontal direction.

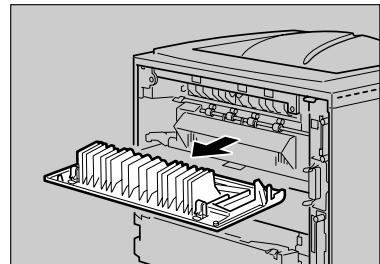

ZKEX620E

Note

- The rear cover of the printer is not used when attaching the duplex unit.
- Store the removed rear cover for possible future use.
- Proceed to step 7 if the paper tray cover is not installed.

6 Pull the bottom of the paper tray cover (1) up slightly, and then remove the paper tray cover (2), in the order shown in the illustration.

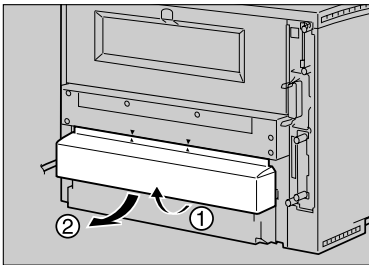

ZKEX780E

7 Push in the duplex unit along the rails at the back of the printer.

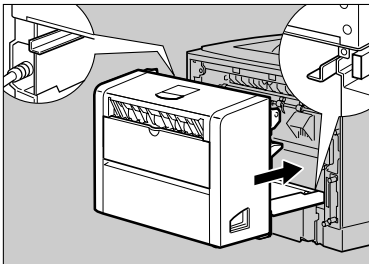

ZKEX231E

8 Push the duplex unit securely into the printer.

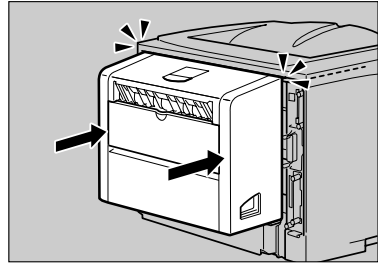

ZKEX830E

3

Note

- After finishing installation, you can check the duplex unit is properly installed: Print the configuration page from the "List/Test Print" menu. If the new device is listed in the column of configuration options, then it has been properly installed.
- If the duplex unit is not installed properly, repeat the procedure from the start. If you cannot install it properly even after reinstallation, contact your sales or service representative.
- If the printing position is not correct, adjust the registration of the trays. For more information about adjusting the registration of the trays, see "Adjusting Tray Registration", Maintenance Guide.

Reference

For printing the configuration page, see p.24 "Test Printing".

3

4. Connecting the Printer

Network Connection

Follow the procedure below to connect the printer to the computer through the network. Prepare the hub and other network devices before connecting the 10 BASE-T or 100 BASE-TX cable to the machine's Ethernet port.

Important

- Use shielded Ethernet cable. Unshielded cables create electromagnetic interference that could cause malfunctions.
- Ethernet cable is not supplied with this machine. Select your cable according to the network environment.

1 On basic model printers that have the network interface board installed, connect the ferrite core to the interface cable. Loop the network interface cable about 15 cm (5.9 inches) (①) from the printer end of the cable.

Network standard model printers do not require a ferrite core.

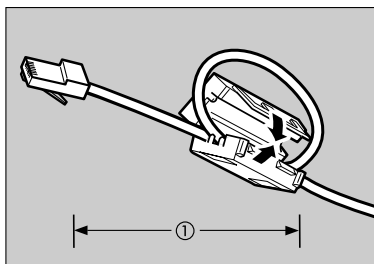

2 Connect the Ethernet cable to the Ethernet port.

For basic model printer, connect the Ethernet cable to the network interface board.

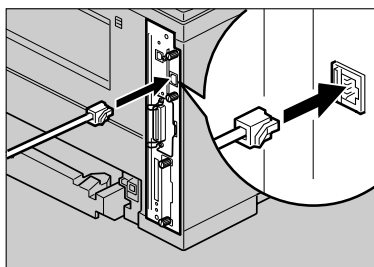

For network standard model printer, connect the Ethernet cable to the standard Ethernet port.

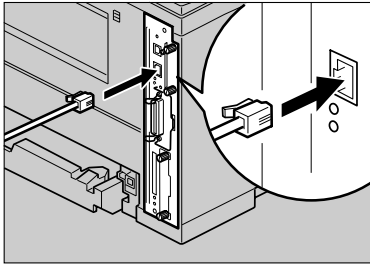

AFE025S

4

3 Connect the other end of the cable to the printer's network, such as a hub.

Reference

For details about network environment settings, see Software Guide.

Reading the LED Lamps

❖ Basic model printer



AFE029S

❖ Network standard model printer

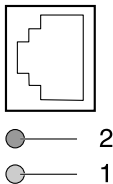

AFE030S

① Yellow: lit when 100BASE-TX is being used. Unlit when 10BASE-T is being used.

② Green: lit when the printer is properly connected to the network.

USB Connection

Important

- USB2.0 interface cable is not supplied. Obtain it separately, according to the computer you are using.
- USB connection is possible under Windows 98 SE/Me/2000/XP, Windows Server 2003, Mac OS 9.x, and Mac OS X v10.3 or higher.
- Windows 98SE/Me supports USB1.1 speeds.
- USB connection with Macintosh is only possible via the printer's USB port.

1 Connect the square-shaped connector of the USB2.0 cable to the USB port.

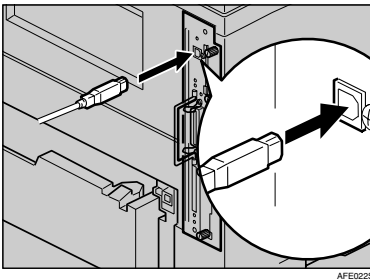

2 Connect the opposite end's flat connector to devices such as your computer's USB interface, or a USB hub.

Reference

For details about settings for USB connection printing, see Software Guide.

Parallel Connection

Important

- The parallel interface cable is not provided with the printer.
- The printer's parallel connection is a standard bidirectional interface that requires an IEEE 1284-compliant 36-pin parallel cable and host computer parallel port.
- Use shielded interface cable. Unshielded cables create electromagnetic interference that could cause malfunctions.

1 Turn off the printer and computer.

2 Connect the cable to the interface connector.

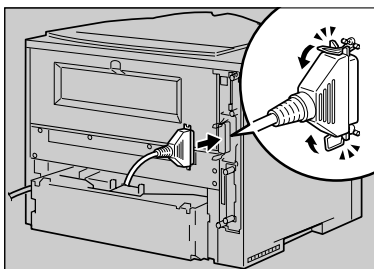

AFE023S

3 Securely attach the other end of the parallel cable to your computer's parallel port. Secure the cable.

Reference

For details about settings for parallel connection printing, see Software Guide.

IEEE 1394 Connection

Important

- Use the 1394 interface cable provided with the 1394 interface unit.
- You cannot plug devices together to create loops.
- Do not use a cable more than 4.5 meters (14.8 feet) long.

1 Connect the interface cable to the 1394 interface unit.

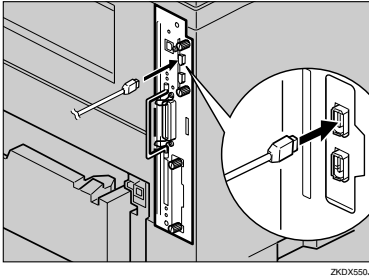

2 Connect the other end to the host computer.

Note

- You can use either connector.
- Either of the two connectors for the 1394 interface unit can be used.
- If you have an interface cable with a ferrite core, connect the ferrite core end to the printer.

Reference

For details about settings for parallel connection printing, see Software Guide.

4

5. Configuration

Ethernet Configuration

Make the following network settings according to the network interface you are using.

You can use SmartDeviceMonitor for Admin or a Web browser to make IP address-related settings in a TCP/IP-capable environment.

Important

- ❑ Configure the printer for the network using the control panel.
- ❑ The following table shows the control panel settings and their default values. These items appear in the **[Host Interface]** menu.

Setting Name	Value	
DHCP	On	
IP Address	011.022.033.044	
Subnet Mask	000.000.000.000	
Gateway Address	000.000.000.000	
Frame Type (NW)	Auto	
Active Protocol	TCP/IP	Active
	NetWare	Active
	SMB	Active
	AppleTalk	Active
Ethernet Speed	Auto	
LAN Type	Ethernet	

Note

- ❑ If DHCP is in use, "IP Address", "Subnet Mask", and "Gateway Address" are all set automatically.
- ❑ Make this setting only when it is necessary. See Software Guide.

- 1 Press the **[Menu]** key.

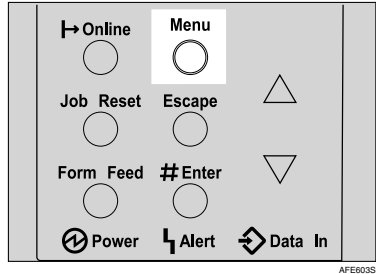

The **[Menu]** screen appears on the display.

- 2 Press the **[▲]** or **[▼]** key to display **[Host Interface]** menu, and then press the **[# Enter]** key.



The interface setting menu appears.

- 3 Press the **[▲]** or **[▼]** key to display **[Network Setup]**, and then press the **[# Enter]** key.

The network setup menu appears.

- 4 Press the **[▲]** or **[▼]** key to display **[Active Protocol]**, and then press the **[# Enter]** key.

- 5 Press the **[▲]** or **[▼]** key to select **Active Protocol**, and then press the **[# Enter]** key.

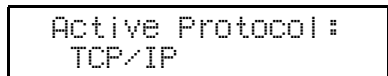

The following example explains activating TCP/IP.

The **[Active]** or **[Not Active]** selection screen appears.

- 6** Press the **[▲]** or **[▼]** key to select **[Active]** or **[Not Active]**, and then press the **[# Enter]** key.

```
TCP/IP:
*Active
```

After the settings are made, about two seconds later, the screen returns to the active protocol menu.

- 7** Set other protocols you need to set in the same way.

- 8** Press the **[Escape]** key, the screen returns to the network setup menu.

 **Note**

- The default is “Active”.
- Leave unused protocols “Not Active”.
- Enable TCP/IP to use the Pure IP environment of NetWare 5/5.1, NetWare 6/6.5.

- 9** If you use TCP/IP, assign the IP address to the printer. Press the **[▲]** or **[▼]** key to display **[IP Address]**, and then press the **[# Enter]** key.

The current IP address appears on the display.

To get the IP address for the printer, contact your network administrator.

- 10** Press the **[▲]** or **[▼]** key to enter the left most entry field of the IP address, and then press the **[# Enter]** key.

```
IP Address:
192.022.033.044
```

Press the **[# Enter]** key, the screen changes, and the next field can then be entered.

 **Note**

- Do not set “011.022.033.044” as the IP address.
- The value moves by 10 if the **[▲]** or **[▼]** key is kept pressed.
- When the **[# Enter]** key is pressed, the cursor moves to the next field.
- To display the previous field, press the **[Escape]** key.
- Press the **[Escape]** key when no value is entered and the screen will return to the network setup menu, without the IP address changing.

- 11** Make the other settings in the same way, and then press the **[# Enter]** key.

```
IP Address:
192.168.000.010
```

After the settings are made, about two seconds later, the screen returns to the network setup menu.

- 12** If you use TCP/IP, assign **[Subnet Mask]** and **[Gateway Address]** following the same procedure for entering the IP address.

- 13** When you use this machine in DHCP environment, set DHCP to “On”.

 **Important**

- When DHCP is “On”, you cannot make settings for the following items:
 - IP Address
 - Subnet Mask
 - Gateway Address

 **Note**

- Consult your network administrator for information about making network settings.

- 14** Press the [▲] or [▼] key to display [DHCP], and then press the [# Enter] key.

```
Network Setup:
  DHCP
```

- 15** Press the [▲] or [▼] key to display [On], and then press the [# Enter] key.

```
DHCP:
 *On
```

 **Note**

- “*” shows the current setting.
- After about two seconds, the display returns to the network setup menu.

- 16** If you use NetWare, select the frame type for NetWare.

Select one of the items below if necessary.

- Auto (Default)
- Ethernet II
- Ethernet 802.2
- Ethernet 802.3
- Ethernet SNAP

 **Note**

- Usually, use the default setting (“Auto”). When you first select “Auto”, the frame type detected by the printer is adopted. If your network can use more than two frame types, the printer may fail to select the correct frame type if “Auto” is selected. In this case, select the appropriate frame type.

- 17** Press the [▲] or [▼] key to display [Frame Type (NW)], and then press the [# Enter] key.

```
Network Setup:
  Frame Type (NW)
```

The current setting appears on the display.

- 18** Press the [▲] or [▼] key to display the frame type you want to use, and then press the [# Enter] key.

```
Frame Type (NW):
 *Auto Select
```

 **Note**

- “Auto” appears on the display for Basic model printer.

After the settings are made, about two seconds later, the screen returns to the network setup menu.

- 19** Press the [Online] key.

The initial screen appears.

```
Ready
```

- 20** Print a configuration page to confirm the settings made.

 **Reference**

For details about printing the configuration page, see p.24 “Test Printing”.

IEEE 802.11b (Wireless LAN) Configuration

Configure the printer to use IEEE 802.11b (Wireless LAN). The following table shows the control panel settings and their default values. These items appear in the **[Host Interface]** menu.

Setting Name	Default Value
Comm. Mode	802.11 Ad hoc
Channel	Inch version: (1-11) 11
	Metric version: (1-13) 13
Trans. Speed	Auto
SSID	blank (ASSID)
WEP Setting	Not Active

Note

- ❑ To use IEEE 802.11b (Wireless LAN), select **[IEEE 802.11b]** for **[LAN Type]** in **[Network Setup]** in the **[Host Interface]** menu, and then set **[IP Address]**, **[Subnet Mask]**, **[Gateway Address]**, **[DHCP]**, **[Frame Type (NW)]** and **[Active Protocol]** under the **[Network Setup]** menu. For details about setting items under “Configuring the Printer for the Network”, see Software Guide.
- ❑ The 802.11b interface unit cannot be used simultaneously with a standard ethernet interface.
- ❑ In the **[SSID]** menu, if blank is specified in 802.11b Ad hoc mode or Ad hoc mode, **[ASSID]** appears.

- 1 Press the **[Menu]** key.

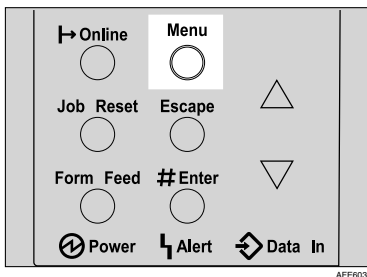

The **[Menu]** screen appears on the display.

- 2 Press the **[▲]** or **[▼]** key to display **[Host Interface]**, and then press the **[# Enter]** key.

```
Menu:
Host Interface
```

The interface setting menu appears.

- 3 Press the **[▲]** or **[▼]** key to display **[IEEE 802.11b]**, and then press the **[# Enter]** key.

The IEEE 802.11b setting menu appears.

- 4 Press the **[▲]** or **[▼]** key to display **[Comm. Mode]**, and then press the **[# Enter]** key.

- 5 Press the **[▲]** or **[▼]** key to select the transmission mode of IEEE 802.11b, and then press the **[# Enter]** key.

```
Comm. Mode:
*802.11 Ad hoc
```

After the settings are made, about two seconds later, the screen returns to the IEEE 802.11b setting menu.

 **Note**

- The factory default is **[802.11 Ad hoc]**.
- To use an IEEE 802.11b card for which the SSID (Network Name) setting is not necessary, select **[Ad hoc]**.
- The transmission mode of IEEE 802.11b can also be set using a Web browser. For details, see Web Image Monitor Help, and “Using Web Image Monitor”, Software Guide.

6 If **[802.11 Ad hoc]** or **[Ad hoc]** is selected for **[Comm. Mode]**, set the channel to use for transmission.

 **Note**

- Confirm the network administrator for the channel to use.

7 Press the **[▲]** or **[▼]** key to display **[Channel]**, and then press the **[# Enter]** key.

The channel currently used appears on the display.

8 Press the **[▲]** or **[▼]** key to enter the channel, and then press the **[# Enter]** key.

```
Channel :
(1-13)   13
```

9 Set **[Trans. Speed]** in the same way.

 **Note**

- The factory default is **[Auto]**. If you need to change the transmitting speed depending on environment you are using, select the appropriate transmitting speed.

10 If **[Infrastructure]** or **[802.11 Ad hoc]** is selected for **[Comm. Mode]**, set SSID to use for transmission.

 **Note**

- Confirm the network administrator for SSID to use.
- SSID can also be set using a Web browser. For details, see the Web Image Monitor Help, and “Using Web Image Monitor”, Software Guide.

11 Press the **[▲]** or **[▼]** key to display **[SSID]**, and then press the **[# Enter]** key.

The following message appears on the display.

```
SSID:
View
```

If an SSID has been set, you can check the set SSID. Press the **[# Enter]** key.

12 Press the **[▲]** or **[▼]** key to display **[Enter ID]**, and then press the **[# Enter]** key.

The following message appears on the display.

```
SSID:      [ 0 ]
■
```

The value in brackets at the upper right is the number of characters entered.

13 Press the **[▲]** or **[▼]** key to select characters, and then press the **[# Enter]** key.

```
SSID:      [ 1 ]
A■
```

You can now enter the next character.

14 Continue entering the key.

 **Note**

- The characters that can be used are ASCII 0x20-0x7e (32 bytes).
- To display the previous character, press the **[Escape]** key.

15 After entering the key, press the **[# Enter]** key twice.

```

SSID:           [32]
AAAAAAAAAAAAAAAA
    
```

After the settings are made, about two seconds later, the screen returns to the IEEE 802.11b setting menu.

16 In the case of using a WEP key on a network, activate the WEP setting to be used for communication along with WEP.

 **Note**

- Confirm the network administrator for the WEP Key to use.
- WEP key can also be set using a Web browser. For details, see Web Image Monitor Help.

17 Press the **[▲]** or **[▼]** key to display **[WEP Setting]**, and then press the **[# Enter]** key.

The following message appears on the display.

```

WEP Setting:
*Not Active
    
```

18 Press the **[▲]** or **[▼]** key to display **[Active]**, and then press the **[# Enter]** key.

The following message appears on the display.

```

Change WEP Key:
Yes (HEX)
    
```

 **Note**

- When setting the WEP Setting to **[Active]**, you will need to enter the WEP key. If you have not entered the key, be sure to enter it.
- If you have entered the WEP key and change the setting, press the **[▲]** or **[▼]** key to display **[No]**, and then press the **[# Enter]** key.

19 Press the **[▲]** or **[▼]** key to display **[Yes (HEX)]** when inputting a hexadecimal WEP key or **[Yes (ASCII)]** when inputting an ASCII WEP key. Then press the **[# Enter]** key.

```

WEP Key:       [ 0 ]
█
    
```

The value in brackets at the upper right is the number of characters entered.

20 Press the **[▲]** or **[▼]** key to select characters, and then press the **[# Enter]** key.

```

WEP Key:       [ 1 ]
*█
    
```

You can now enter the next character.

```

WEP Key:       [ 2 ]
**█
    
```

Continue entering the key.

Note

- When using 64 bit WEP, up to 10 characters can be used for hexadecimal and up to five characters for ASCII. When using 128 bit WEP, up to 26 characters can be used for hexadecimal and up to 13 characters for ASCII.
- The number of characters that can be entered is limited to 10 or 26 for hexadecimal and 5 or 13 for ASCII. If you try to enter too many characters, the following message appears:
 - hexadecimal

```
Error: Enter 10
or 26 characters
```

- ASCII

```
Error: Enter 5
or 13 characters
```

- For ASCII character strings, each capital letter and lowercase letter is recognized respectively.
- To display the previous character, press the **[Escape]** key.

21 After entering the key, press the **[# Enter]** key.

```
WEP Key: [26]
*****A
```

After the settings are made, about two seconds later, the screen returns to the IEEE 802.11b setting menu.

22 Press the **[Online]** key.

The initial screen appears.

```
Ready
```

23 Print a configuration page to confirm the settings made.**Reference**

For details about printing the configuration page, see p.24 "Test Printing".

IEEE 1394 Configuration

Use this procedure to configure the printer for use in an IEEE 1394 environment. The following table shows the control panel settings and their default values. These items appear in the **[Host Interface]** menu.

Setting Name	Value
DHCP	On
IP Address1394	011.022.033.044
Subnet Mask1394	000.000.000.000
IP over 1394	Active
SCSI print	Active
Bidi-SCSI print	On

Note

- If DHCP is in use, "IP Address1394" and "Subnet Mask1394" are automatically set.
- The value of "Bidi-SCSI print" is set to "Active" for basic model printer.

IP over 1394

- 1** Press the **[Menu]** key.

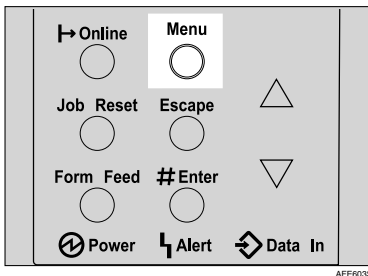

The **[Menu]** screen appears on the display.

- 2** Press the **[▲]** or **[▼]** key to display **[Host Interface]**, and then press the **[# Enter]** key.

```
Menu:
Host Interface
```

The interface setting menu appears.

- 3** Press the **[▲]** or **[▼]** key to display **[IEEE 1394 Setup]**, and then press the **[# Enter]** key.

The IEEE 1394 setting menu appears.

- 4** Press the **[▲]** or **[▼]** key to display **[IP over 1394]**, and then press the **[# Enter]** key.

The IP over 1394 setting menu appears.

- 5** Press the **[▲]** or **[▼]** key to select either **[Active]** or **[Not Active]**, and then press the **[# Enter]** key.

```
IP over 1394:
*Active
```

After the settings are made, about two seconds later, the screen returns to the IEEE 1394 setting menu.

- 6** Assign the IP address to the printer. Press the **[▲]** or **[▼]** key to display **[IP Address1394]**, and then press the **[# Enter]** key.

The current IP address appears on the display.

Note

- ❑ Do not set the same IP address as that used for the Ethernet network settings or in the same subnet. Also, do not specify the same subnet mask.
- ❑ Do not set “011.022.033.044” as the IP address.
- ❑ To get the IP address for the printer, contact your network administrator.

- 7** Press the **[▲]** or **[▼]** key to enter the left most entry field of the IP address, and then press the **[# Enter]** key.

```
IP Address1394:
19▣.022.033.044
```

The pointer (▣) moves to the next entry field automatically.

```
IP Address1394:
192.02▣.033.044
```

Note

- ❑ The value moves by 10 if the **[▲]** or **[▼]** key is kept pressed.
- ❑ You can return the pointer (▣) to the previous (left) entry field by pressing the **[Escape]** key.
- ❑ If you press the **[Escape]** key when the pointer (▣) is on the leftmost position, the selected IP address is reset.

- 8** Set other fields similarly, and then press the **[# Enter]** key.

The settings are made and after about two seconds, the screen returns to the IEEE 1394 setting menu.

- 9** Set **[Subnet Mask1394]** in the same way.

- 10** Press the **[Online]** key.

The initial screen appears.

```
Ready
```

- 11** Print a configuration page to confirm the settings made.

Reference

For printing the configuration page, see “Printing a Configuration Page”, Software Guide.

SCSI print

- 1** Press the **[Menu]** key.

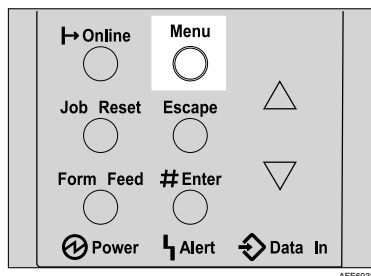

The **[Menu]** screen appears on the display.

- 2** Press the **[▲]** or **[▼]** key to display **[Host Interface]**, and then press the **[# Enter]** key.

```
Menu:
Host Interface
```

The interface setting menu appears.

- 3** Press the **[▲]** or **[▼]** key to display **[IEEE 1394 Setup]**, and then press the **[# Enter]** key.

The IEEE 1394 setting menu appears.

- 4 Set [SCSI print] and [Bidi-SCSI print] if necessary.

 **Note**

- The default setting is “Active”.

- 5 Press the [▲] or [▼] key to display [SCSI print], and the press the [# Enter] key.

- 6 Press the [▲] or [▼] key to select either [Active] or [Not Active], and then press the [# Enter] key.

```
SCSI Print:
*Active
```

After the settings are made, about two seconds later, the screen returns to the IEEE 1394 setting menu.

- 7 Set [Bidi-SCSI print] in the same way.

- 8 Press the [Online] key.

The initial screen appears.

```
Ready
```

- 9 Print a configuration page to confirm the settings made.

 **Reference**

For details about printing the configuration page, see p.24 “Test Printing”.

6. Installing the Printer Driver

Quick Install

Windows 95/98/Me/2000/XP, Windows Server 2003, and Windows NT 4.0 users can easily install this software using the CD-ROM provided.

Using Quick Install, the PCL printer driver and RPCS printer driver and SmartDeviceMonitor for Client is installed under network environment, and TCP/IP port will be set.

Important

- To install printer driver under Windows 2000/XP Professional, Windows Server 2003, and Windows NT 4.0, you must have an account that has Manage Printers permission. Log on as an Administrator.
- Only the printer driver, and not the SmartDeviceMonitor for Client, is installed when using this printer under USB, parallel, or 1394 connection. If you connect using USB, see Software Guide.

1 Quit all applications currently running.

2 Insert the CD-ROM into the CD-ROM drive.

The installer starts.

Auto Run may not work with certain operating system settings. If this happens, launch "Setup.exe" on the CD-ROM root directory.

3 Select an interface language, and then click [OK].

The default interface language is English.

4 Click [Quick Install].

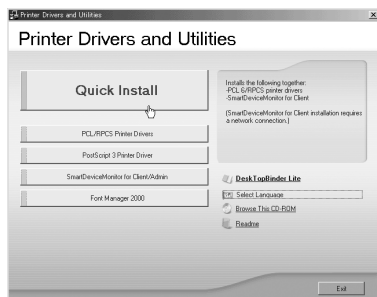

The software license agreement appears in the [License Agreement] dialog box.

5 After reading the agreement, click [I accept the agreement], and then click [Next].

6 Select the printer model you want to use in the **[Select Printer]** dialog box.

 **Note**

- For network connection via TCP/IP, select the printer whose IP address is displayed in **[Connect To]**.
- For parallel connection, select the printer whose printer port is displayed in **[Connect To]**.

7 Click **[Install]**.

The printer driver installation starts.

8 Click **[Finish]**.

A message about restarting the computer may appear. Restart the computer to complete installation.

9 Click **[Exit]** in the first dialog box of the installer, and then take out the CD-ROM.

 **Note**

- To stop installation of the selected software, click **[Cancel]** before installation is complete. Restart the computer, and then reinstall the other software or printer drivers.
- Auto Run may not work with certain operating system settings. If this happens, launch "Setup.exe" on the CD-ROM root directory.
- Select a printer to whose IP address is displayed in **[Connect To]** to install SmartDeviceMonitor for Client when using TCP/IP.

 **Reference**

Quick Install is not available unless bidirectional communication between the printer and computer is enabled via parallel connection. See "Install SmartDeviceMonitor for Client from the CD-ROM provided.", Software Guide, for details about bidirectional communication between printer and computer.

Install the Operating Instructions

The CD-ROM provided with the printer contains an HTML Operating Instructions Manual in HTML version. Follow the above instructions to install it.

Important

System Requirements :

- Windows 95/98/Me, Windows 2000/XP, Windows Server 2003 or Windows NT4.0.
- 800 x 600 or higher monitor resolution.

Web Browsers :

- Microsoft Internet Explorer 4.01 SP2 or later.
- Netscape 6.2 or later.

- If you are using Internet Explorer 3.02 or earlier, or Netscape Navigator 4.05 or earlier as your Web browser, a simpler version of the Operating Instructions Manual is displayed.

1 Quit all applications currently running.

2 Insert the CD-ROM into the CD-ROM drive.

The installer starts.

Auto Run may not work under certain operating system setting. If this is the case, launch "Setup.exe" on the CD-ROM root directory.

3 Select an interface language, and then click [OK].

4 Click [Install manuals].

5 Follow the instructions on the screen to complete the installation.

6 Click [Finish] when the installation is completed.

7 Click [Exit].

Note

- Auto Run may not work under certain operating system setting. If this is the case, copy all datas on the CD-ROM root directory to your hard disk drive, and then launch "Setup.exe" to start the installation.
- To uninstall the Operating Instructions Manual, select [**Programs**] in the [**Start**] menu, select your printer driver, and then click [**Uninstall**]. You can uninstall each Manual Guide separately.
- If you are using an incompatible Web browser and the simpler version of the Operating Instructions Manual does not correctly display correctly, open folder "MANUAL\R_MANUAL\ (language) \ (SETUP or MAINTENANCE or SOFTWARE) \unv\" on the CD-ROM. Double-click on "index.htm".

INDEX

1394 Interface Unit, 25, 39, 59, 68
802.11b Interface Unit, 25, 42, 64

A

AD450 (Duplex Unit), 25, 52
Attaching 1394 Interface Unit, 39
Attaching 802.11b Interface Unit, 42
Attaching AD450 (Duplex Unit), 52
Attaching Bluetooth Interface Unit, 46
Attaching Envelope Feeder Type 400, 32
Attaching Hard Disk Drive, 50
Attaching Memory Unit
(SDRAM module), 33
Attaching
 Network Data Protection Unit, 51
Attaching Network Interface Board, 36
Attaching Paper Feed Unit Type 400, 30
Available Options, 25

B

Bluetooth Interface Unit, 25, 46

C

Checking the Contents of the Box, 16
Configuration
 Ethernet Configuration, 61
 IEEE 1394 Configuration, 68
 IEEE 802.11b (Wireless LAN)
 Configuration, 64
Configuration Page, 24
Connecting the Printer
 IEEE 1394 Connection, 59
 Network Connection, 55
 Parallel Connection, 58
 USB Connection, 57

D

Display Language, 23
Duplex Unit, 52

E

Energy Star, 6
Envelope Feeder Type 400, 25, 32
Ethernet, 55, 61
Ethernet Port, 55

G

Guide to the Printer
 Control Panel, 12
 Exterior, 9
 Inside, 11

H

Hard Disk Drive, 25, 50

I

Installing Options, 25
Installing the Printer Driver, 71
Install the Operating Instructions, 73
IP Address, 61

L

Loading Paper, 20

M

Memory Unit (SDRAM module), 25, 33

N

Network, 55, 61
Network Data Protection Unit, 25, 51
Network Interface Board, 36

O

Option Installation Flow Chart, 26
Option List, 25

P

Paper Feed Unit Type 400, 25, 30

Q

Quick Install, 71

S

Safety Information, 2

Setting Up, 13

T

Test Printing, 24

Toner Cartridge, 17

Tray 1, 20

Turning the Power On, 22

U

Unpacking, 16

USB Port, 57

W

Where to Put the Printer, 13

Wireless LAN, 64

MEMO

MEMO

MEMO

In accordance with IEC 60417, this machine uses the following symbols for the main power switch:

I means **POWER ON**.

O means **POWER OFF**.



Declaration of Conformity

“The Product complies with the requirements of the EMC Directive 89/336/EEC and its amending directives and the Low Voltage Directive 73/23/EEC and its amending directives.”



Declaration of Conformity

Notice to Users in EEA Countries

802.11b Interface Unit Type F (R-WL11B):

This product complies with the essential requirements and provisions of Directive 1999/5/EC of the European Parliament and of the Council of 9 March 1999 on radio equipment and telecommunications terminal equipment and the mutual recognition of their conformity.

The CE Declaration of Conformity is available on the Internet at URL:

http://www.ricoh.co.jp/fax/ce_doc/.

Outdoor use of this product is prohibited in France and Italy.



RICOH COMPANY, LTD.

15-5, Minami Aoyama 1-chome,
Minato-ku, Tokyo 107-8544, Japan
Phone: +81-3-3479-3111



Afficio™
AP410N/AP410

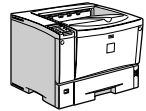

Setup Guide

Overseas Affiliates

USA

RICOH CORPORATION
5 Dedrick Place
West Caldwell, New Jersey 07006
Phone: +1-973-882-2000

The Netherlands

RICOH EUROPE B.V.
Groenelaan 3, 1186 AA, Amstelveen
Phone: +31-(0)20-5474111

United Kingdom

RICOH UK LTD.
Ricoh House,
1 Plane Tree Crescent, Feltham,
Middlesex, TW13 7HG
Phone: +44-(0)20-8261-4000

Germany

RICOH DEUTSCHLAND GmbH
Wilhelm-Fay-Strasse 51,
D-65936 Frankfurt am Main
Phone: +49-(0)69-7104250

France

RICOH FRANCE S.A.
383, Avenue du Général de Gaulle
BP 307-92143 Clamart Cedex
Phone: +33-(0)-821-01-74-26

Spain

RICOH ESPAÑA S.A.
Avda. Litoral Mar, 12-14,
Blue Building, Marina Village,
08005 Barcelona
Phone: +34-(0)93-295-7600

Italy

RICOH ITALIA SpA
Via della Metallurgia 12,
37139 Verona
Phone: +39-045-8181500

China

RICOH CHINA CO.,LTD.
29/F., Lippo Plaza, No.222
Huai Hai Zhong Road,
Lu Wan District,
Shanghai P.C.:200021
Phone: +86-21-5396-6888

Singapore

RICOH ASIA PACIFIC PTE.LTD.
260 Orchard Road,
#15-01/02 The Heeren,
Singapore 238855
Phone: +65-6830-5888

Model number: Aficio AP410N/AP410

Printed in the Netherlands

GB  G112-8614A



G1128614A